

## 5655 Valisette Pirate et radeau





# playmobil®

## 5655



**WARNING:**  
CHOKING HAZARD

Small parts. Not for children under 3 years.

"Ne concerne que les USA"

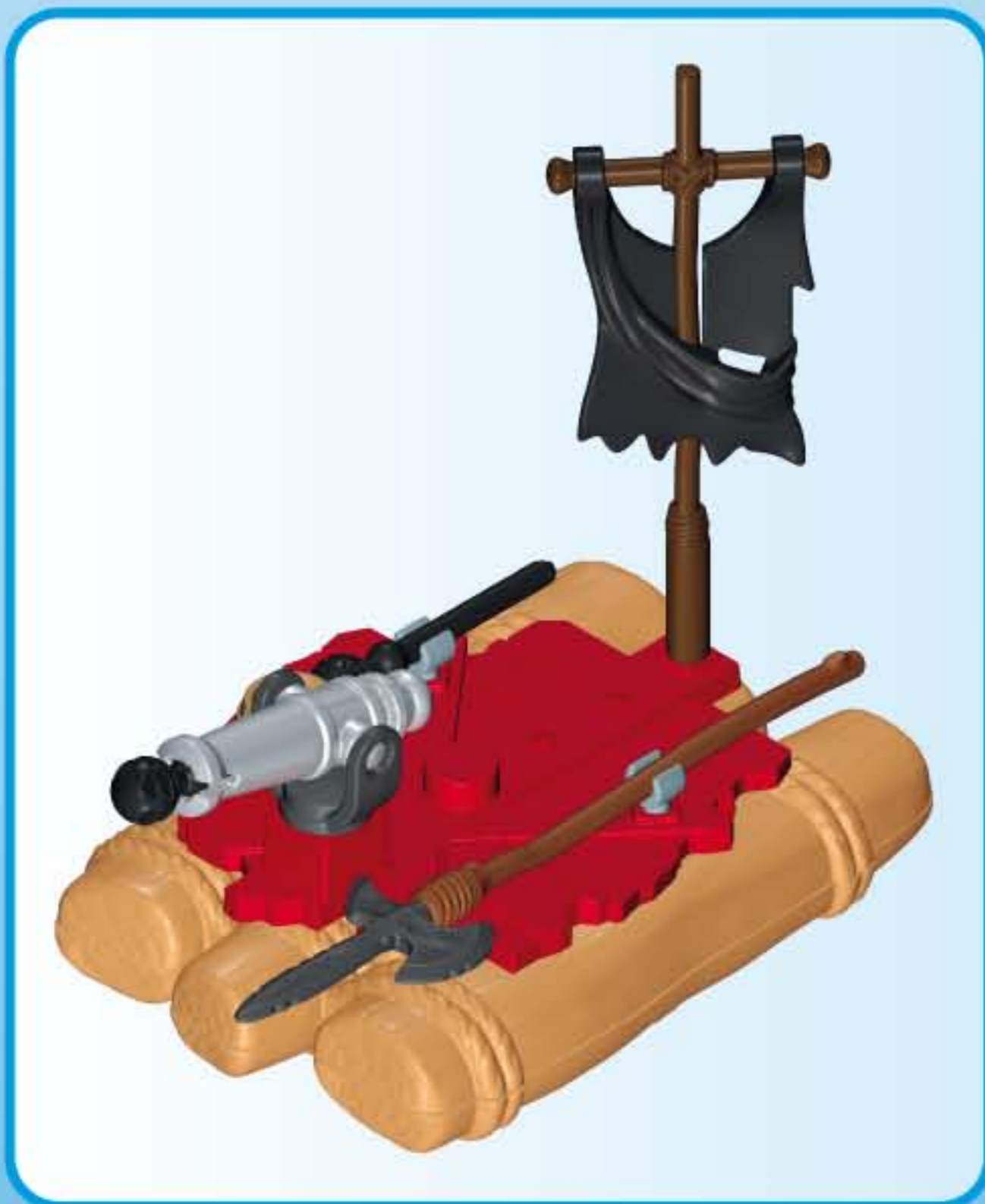

Wichtige Unterlagen, bitte sorgfältig aufbewahren !  
Important: Please keep these instructions for future reference !  
Documents importants, à conserver soigneusement !  
Belangrijke documenten, bewaar deze zorgvuldig !

1

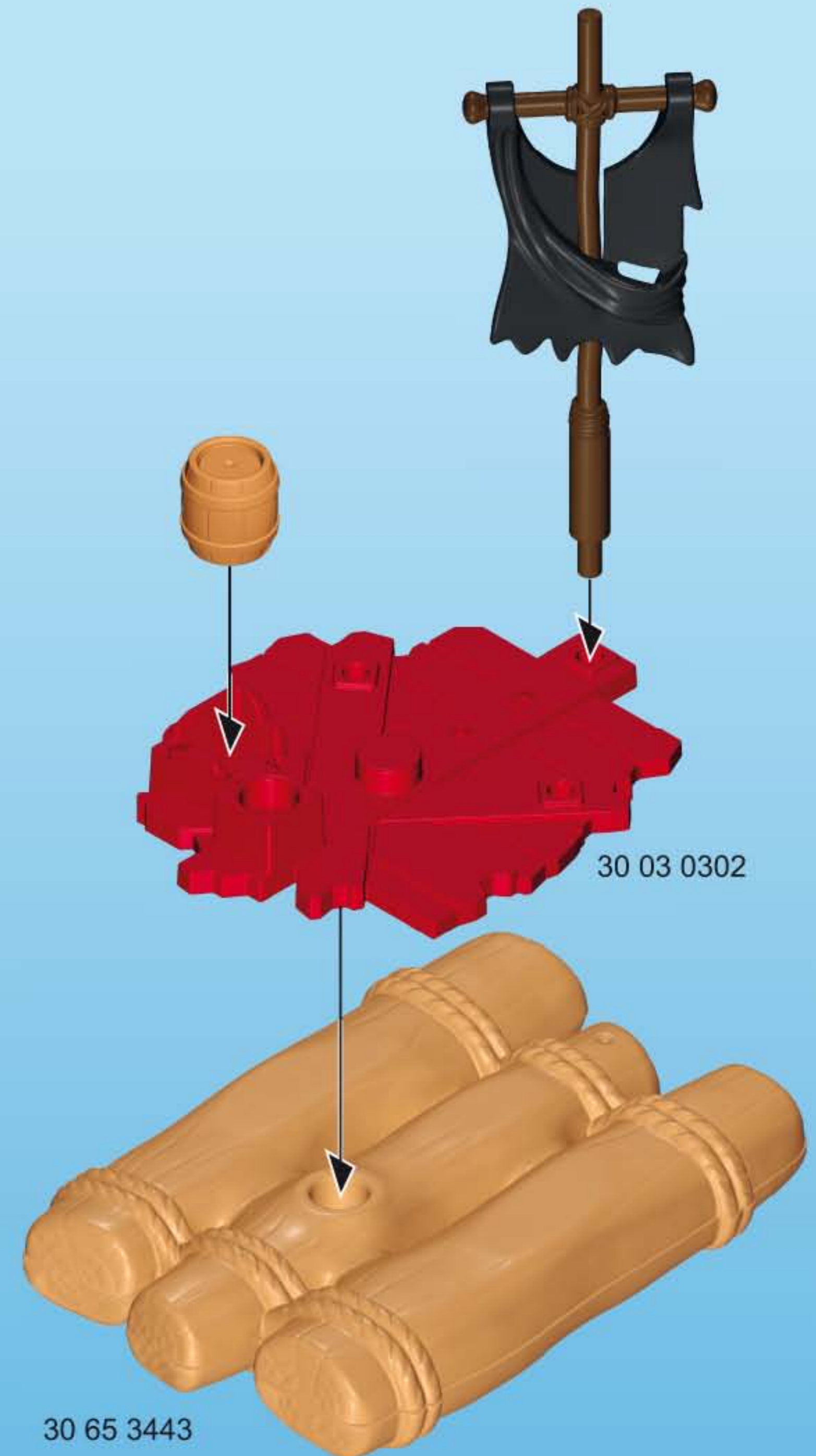

2

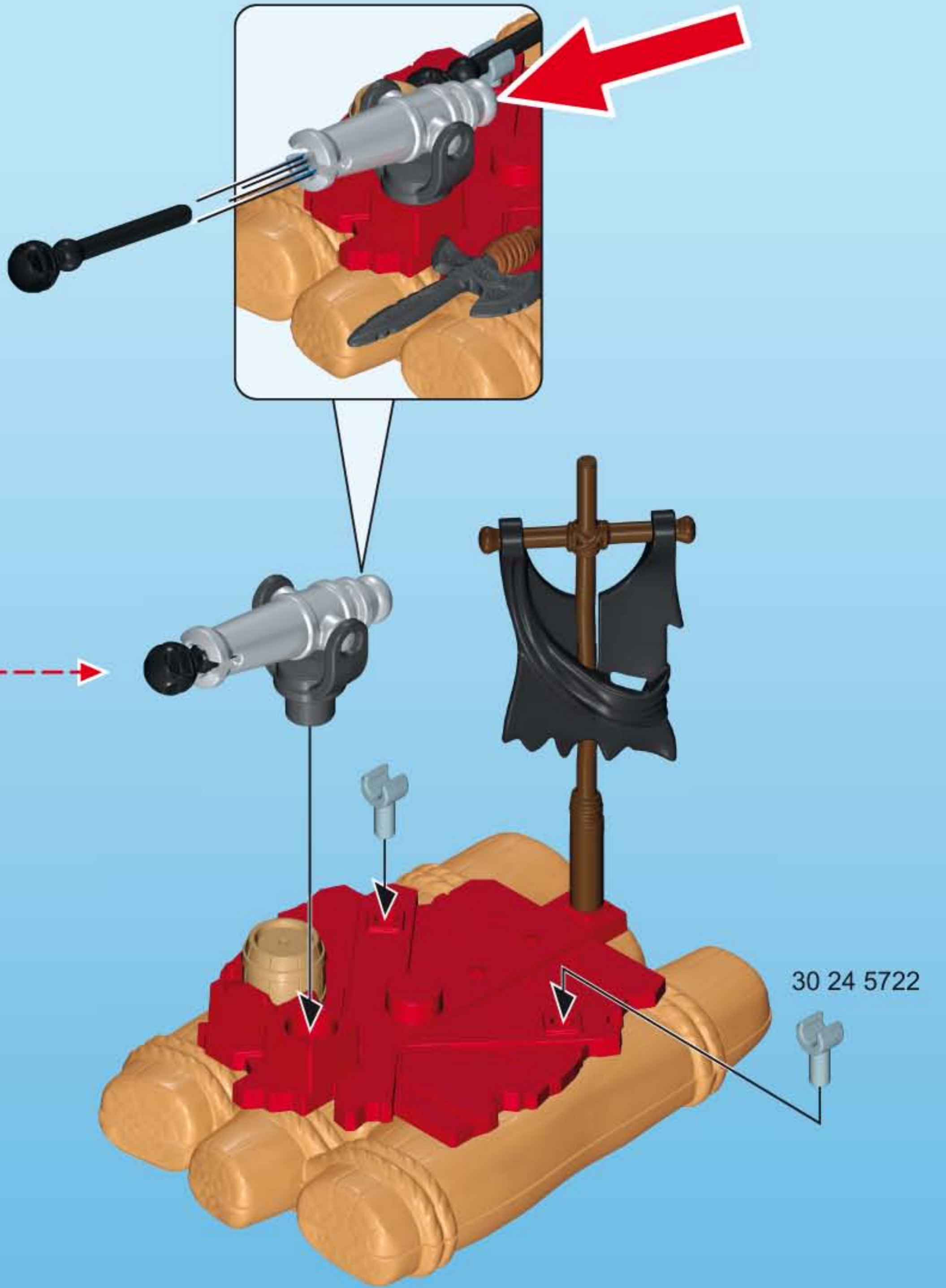
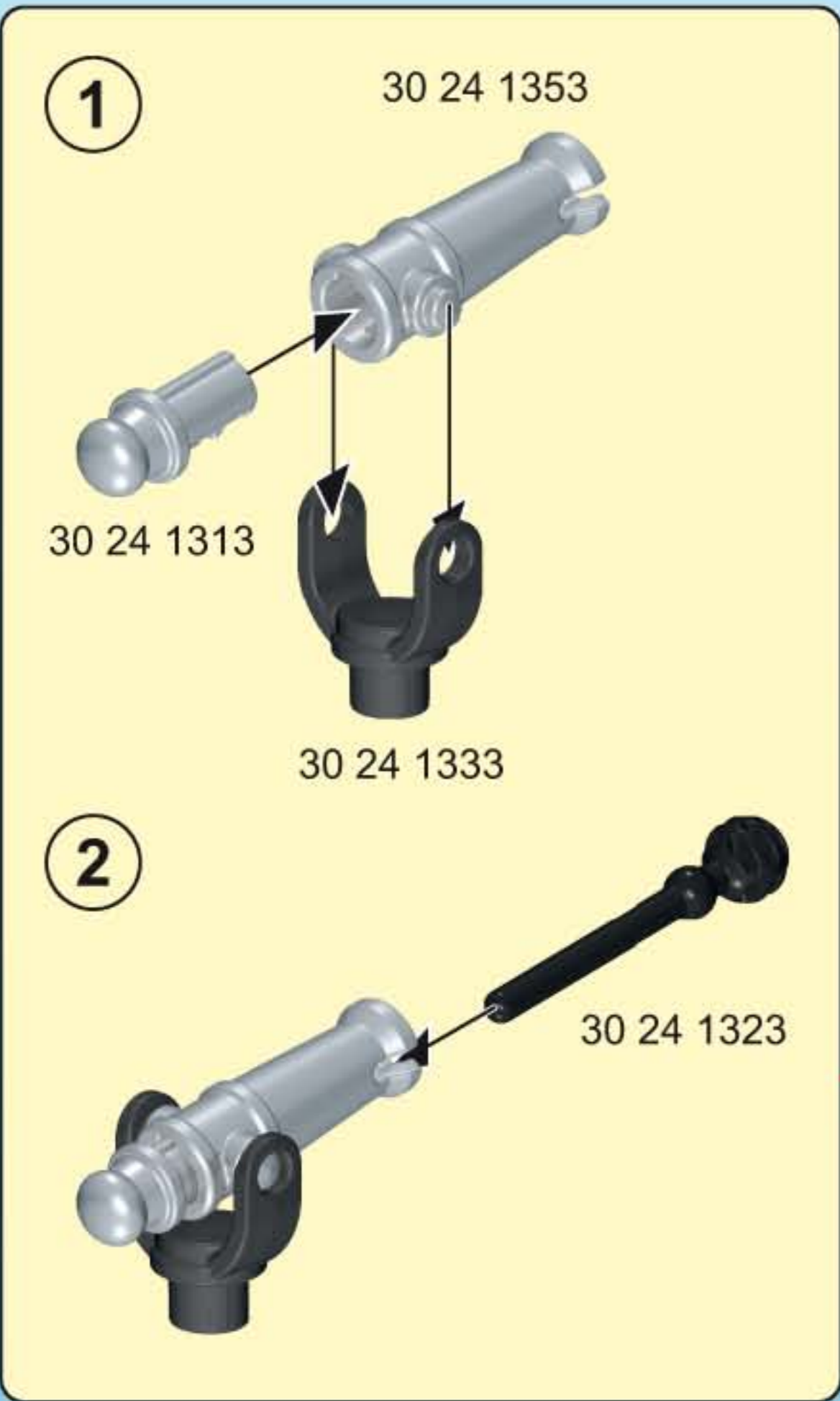

**D A CH L B ACHTUNG!**

- Nur im flachen Wasser unter Aufsicht von Erwachsenen verwenden. Nach dem Spielen austrocknen lassen.
- Nur mitgelieferte PLAYMOBIL Geschosse verwenden. Nicht auf Augen oder Gesicht zielen.

**USA GB CDN M IRL WARNING!**

- Only to be used in water in which the child is within its depth and under adult supervision. Dry thoroughly after play.
- Only use the PLAYMOBIL projectiles supplied. Do not aim at eyes or face.

**F CDN B L CH ATTENTION!**

- À n'utiliser qu'en eau où l'enfant a pied et sous la surveillance d'un adulte. Faire sécher après chaque utilisation.
- Seulement utiliser les projectiles PLAYMOBIL fournis. Ne pas viser les yeux ou le visage.

**E MEX ¡ADVERTENCIA!**

- Utilizar sólo en agua donde el niño pueda permanecer de pie y bajo vigilancia de un adulto. Dejar secar antes de guardar.
- Utiliza únicamente los proyectiles PLAYMOBIL suministrados. No apuntar a los ojos ni a la cara.

**NL B WAARSCHUWING!**

- Gebruiken in water waar kinderen kunnen staan en onder toezicht van volwassenen. Na het spelen laten drogen.
- Uitsluitend meegeleverde PLAYMOBIL delen gebruiken. Niet op ogen of gezicht richten.

**I CH AVVERTENZA!**

- Da utilizzare unicamente in acqua dove il bambino tocca il fondo con i piedi e sotto la sorveglianza di un adulto. Asciugare bene dopo ogni uso.
- Usare soltanto i proiettili PLAYMOBIL in dotazione. Non mirare agli occhi o al viso.

**P ATENÇÃO!**

- Só utilizar em água onde a criança tenha pé e sob vigilância de adultos. Deixar secar antes de guardar.
- Usar apenas os projécteis PLAYMOBIL juntamente fornecidos. Não apontar para os olhos ou face.

**DK ADVARSEL!**

- Må kun anvendes under opsyn af en voksen og på vanddybder, hvor barnet kan bunde. Lad det tørre ud når du er færdig med at lege.
- Anvend kun de medfølgende PLAYMOBIL projektiler. Sigt ikke mod øjne eller ansigt.

**N ADVARSEL!**

- Skal kun brukes i vann som ikke er for dypt for barnet, og der barnet er under tilsyn. Tørk opp etter at leken er ferdig.
- Benytt kun PLAYMOBIL prosjektil som leveres med. Sikt ikke på ansikt eller øyne.

**S FIN VARNING!**

- Får endast användas i vatten där barnet bottnar och under tillsyn av en vuxen. Låt torka efter användandet.
- Använd endast medlevererade PLAYMOBIL-skott. Sikta inte mot ögon eller ansikte.

**FIN VAROITUS!**

- Lelua saa käyttää vain aikuisen valvonnassa vedessä, jossa lapsi ylettyy pohjaan. Anna kuivua leikin jälkeen.
- Käytä vain mukana toimitettuja PLAYMOBIL-ammuksia. Ei saa kohdistaa suoraan silmiin tai kasvoihin.

**H FIGYELMEZTETÉS.**

- Csak a gyermek magasságához képest biztonságos sekély vízben és felnőtt felügyelete mellett szabad használni! Játék után ajánlott a termék kiszárítása!
- Csak a csomagban található PLAYMOBIL lövedékeket szabad használni. Tilos szemre vagy arcra célozni.

**CZ UPOZORNĚNÍ!**

- Používáť pouze ve vodě takové hloubky, kde dítě stačí, a pouze pod dohledem dospělé osoby. Po hraní nechat vyschnout.
- Používejte pouze střely PLAYMOBIL, které jsou součástí dodávky. Nemiřte na oči nebo na obličej!

**EST HOIATUS!**

- Kasutada ainult täiskasvanu järelevalve all vees, kus laps ulatub jalgadega põhja. Mängimise järel kuivatada!
- Kasutage ainult kaasaantud PLAYMOBIL'i laskemoona. Ära sihi silmadesse ega näkku.

**LV BRĪDINĀJUMS!**

- Lietot tikai sekļā ūdenī un pieaugušo uzraudzībā. Pēc spēlēšanās ļaut nožūt.
- Izmantot tikai PLAYMOBIL piegādes komplektā iekļautos šāviņus. Nevērst pret acīm vai seju.

**LT ĮSPĖJIMAS!**

- Naudoti tik vaikui tinkamame gylyje ir prižiūrint suaugusiesiems. Pažaidus, išdžiovinkite.
- Naudokite tik pridedamus PLAYMOBIL šaudmenis. Netaikyti į akis arba veidą.

**SLO OPOZORILO!**

- Uporabljajte samo v vodi, primerno plitvi za otroka in pod nadzorom odrasle osebe. Po igri naj se igrača posuši.
- Uporabljajte le priložene PLAYMOBIL-ove krogle. Ne merite v oči ali obraz.

**SK UPOZORNENIE!**

- Používať len vo vode, v ktorej dieťa dočiahne na dno, a pod dohľadom dospelej osoby. Po hre nechať vyschnúť.
- Používajte len náboje dodávané spolu so sadou PLAYMOBIL. Nemieriť do očí alebo do tváre.

**PL OSTRZEŻENIE!**

- Do używania jedynie w wodzie na głębokości, na której dziecko wyczuwa dno pod nogami oraz pod nadzorem osoby dorosłej. Po zabawie pozostaw do wyschnięcia.
- Stosować tylko załączone PLAYMOBIL - kule / pociski. Nie celować w oczy i twarz.

**TR CY DİKKAT!**

- Sadece denetim altında ve sadece alçak sularda kullanın. Oyundan sonra kurumaya bırakın.
- Sadece birlikte verilen PLAYMOBIL mermileri kullanınız. Göze veya yüze doğru tutmayınız.

**GR CY Προειδοποίηση!**

- Να χρησιμοποιείται μόνο σε νερά όπου πατώνει το παιδί και υπό την επίβλεψη ενηλίκου. Μόλις τελειώσετε, αφήστε το παιχνίδι να στεγνώσει εντελώς.
- Να χρησιμοποιούνται αποκλειστικά τα βλήματα της PLAYMOBIL που περιέχονται στη συσκευασία. Μη μην γίνεται στόχευση στα μάτια ή στο πρόσωπο.

**RO AVERTISMENT!**

- A se utiliza numai acolo unde copilul poate sta în picioare în apă și este sub supraveghere. După joacă se lasă să se usuce.
- Se folosesc doar proiectilele incluse PLAYMOBIL. Nu se țintește în ochi sau în față.

**BG Внимание!**

- Да се използва само във вода, която е дълбока до нормалния ръст на детето, и под надзора на възрастен. След игра оставете да изсъхне.
- Използвайте само приложени PLAYMOBIL снаряди. Не насочвайте към очите и лицето.

**HR UPOZORENJE!**

- Koristiti samo u plitkoj vodi pod nadzorom odraslih. Poslije igranja pustiti da se osuši.
- Upotrijebiti samo od strane PLAYMOBIL-a isporučene projekte. Ne ciljati u oči ili lice.

**CN 警告!**

- 可供孩子在水中使用，但必须在有人监护的情况下。玩耍后要干燥。
- 仅能用PLAYMOBIL的炮弹。禁止瞄准眼睛或脸。请勿瞄准眼睛或脸。

3

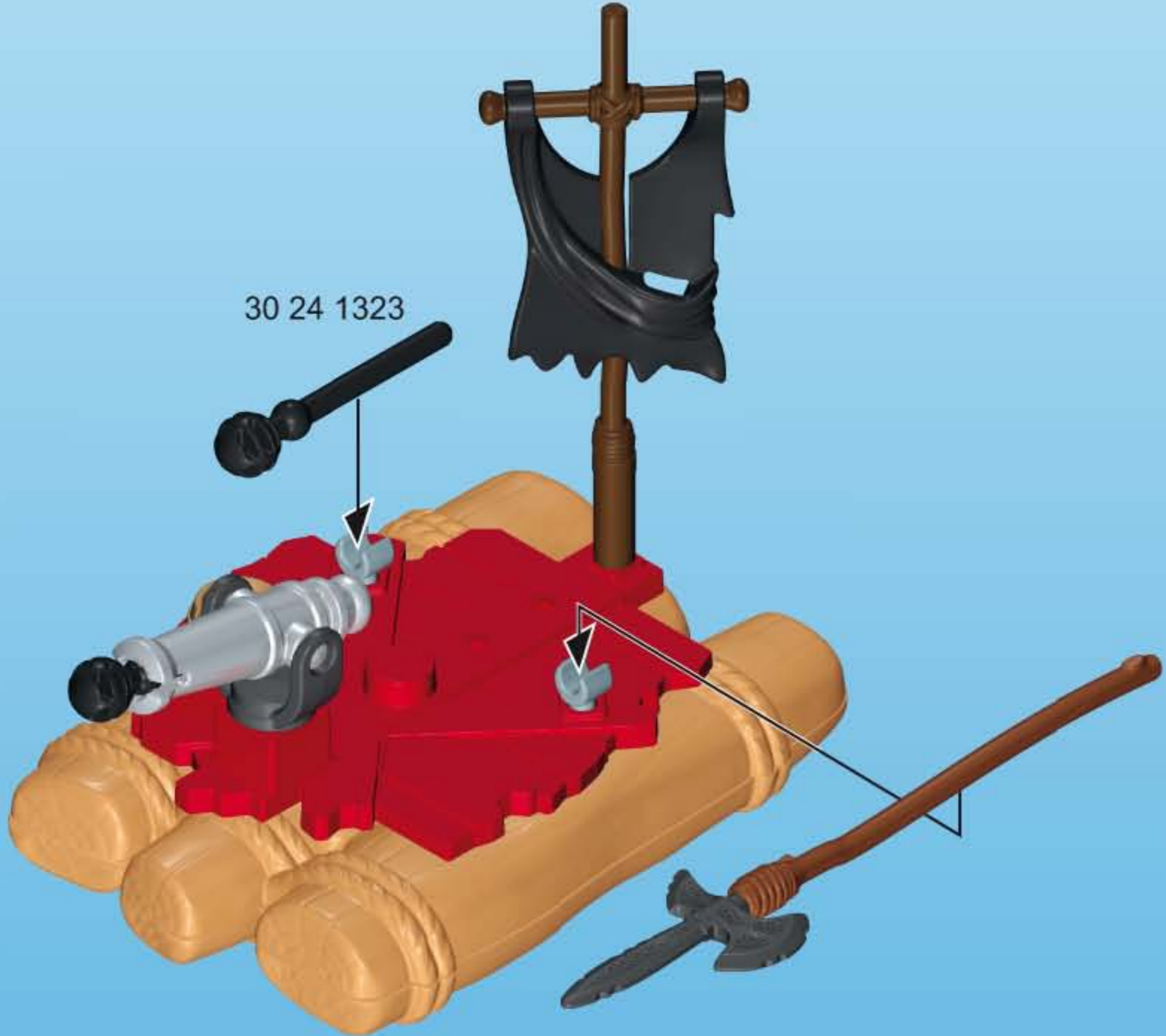
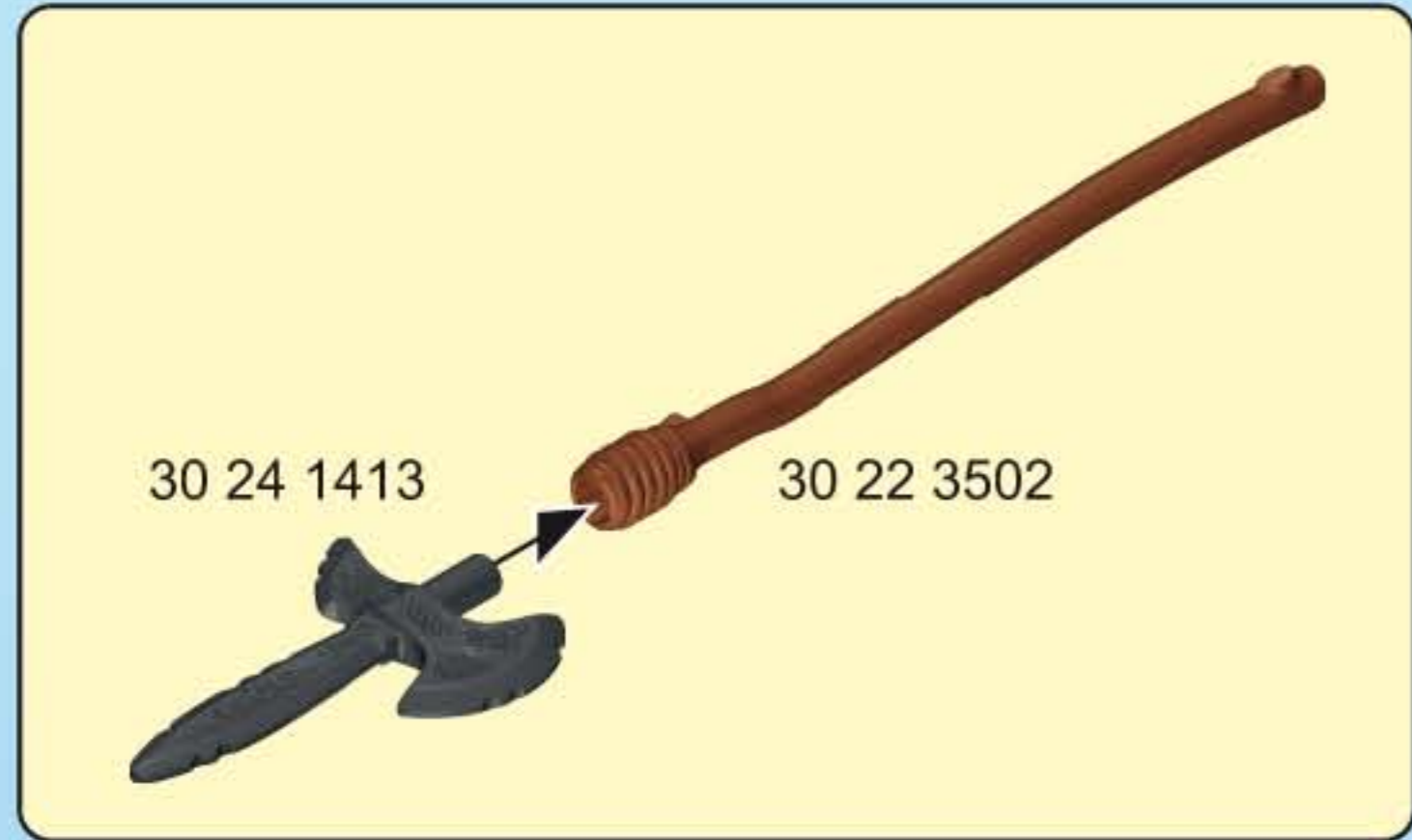

30 03 0342



30 23 8580



30 13 1390



30 06 0710

Serviceadressen finden Sie in allen Playmobil-Prospekten

Addresses of Customer Service Departments are shown in all Playmobil catalogues

L'adresse du service consommateurs est indiquée dans tous les catalogues Playmobil

Troverete gli indirizzi dei centri di assistenza in tutti i cataloghi Playmobil

In alle PLAYMOBIL catalogi vindt u het adres van onze klantendienst.

Las Direcciones de los Departamentos de Servicio al Consumidor se encuentran en todos los catálogos Playmobil

Η διεύθυνση του Γραφείου Εξυπηρέτησης Καταναλωτών PLAYMOBIL βρίσκεται σε όλους τους καταλόγους PLAYMOBIL.

pronounce: plāy-mō-bēēl



© 2016 geobra Brandstätter Stiftung & Co.KG  
Brandstätterstr. 2-10  
90513 Zirndorf, Germany.  
No. 30 82 7554 01.16

www.playmobil.com

# 5971 Valisette maîtresse et élèves







# 6635 Parc animalier avec visiteurs







**playmobil®**

6635



**WARNING:  
CHOKING HAZARD**

Small parts. Not for children under 3 years.

"Ne concerne que les USA"



Wichtige Unterlagen, bitte sorgfältig aufbewahren !  
Important: Please keep these instructions for future reference !  
Documents importants, à conserver soigneusement !  
Belangrijke documenten, bewaar deze zorgvuldig !

Serviceadressen finden Sie in allen Playmobil-Prospekten

Addresses of Customer Service Departments are shown in all Playmobil catalogues

L'adresse du service consommateurs est indiquée dans tous les catalogues Playmobil

Troverete gli indirizzi dei centri di assistenza in tutti i cataloghi Playmobil

In alle PLAYMOBIL catalogi vindt u het adres van onze klantendienst.

Las Direcciones de los Departamentos de Servicio al Consumidor se encuentran en todos los catálogos Playmobil

Η διεύθυνση του Γραφείου Εξυπηρέτησης Καταναλωτών PLAYMOBIL βρίσκεται σε όλους τους καταλόγους PLAYMOBIL.

pronounce: plāy-mō-bēēl

1

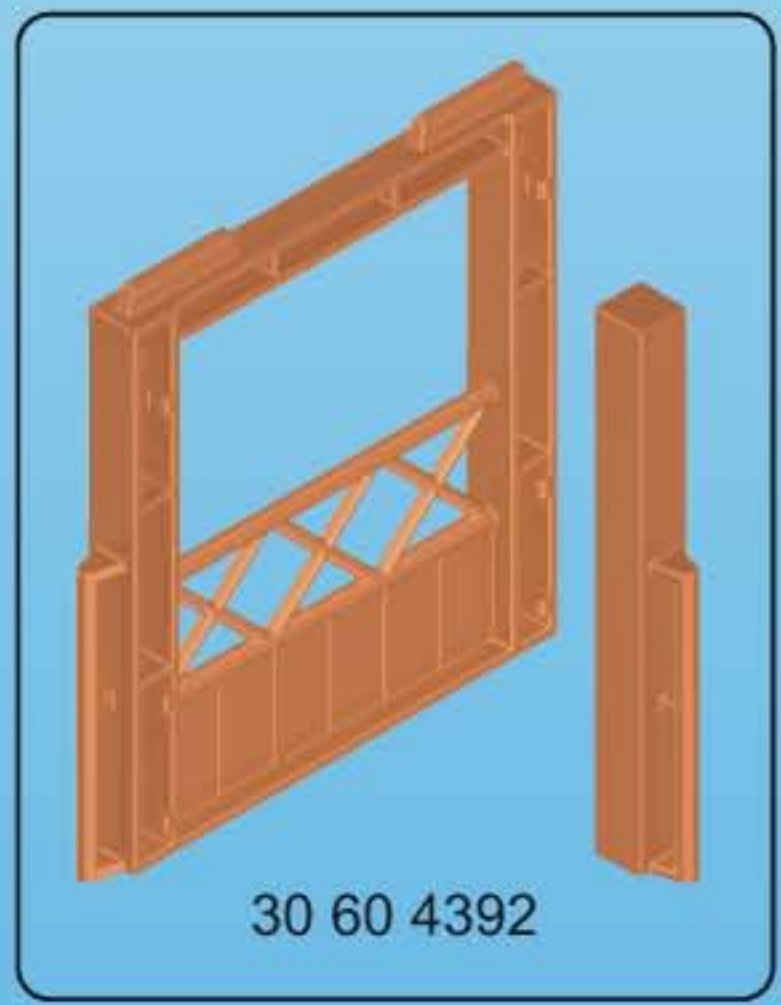
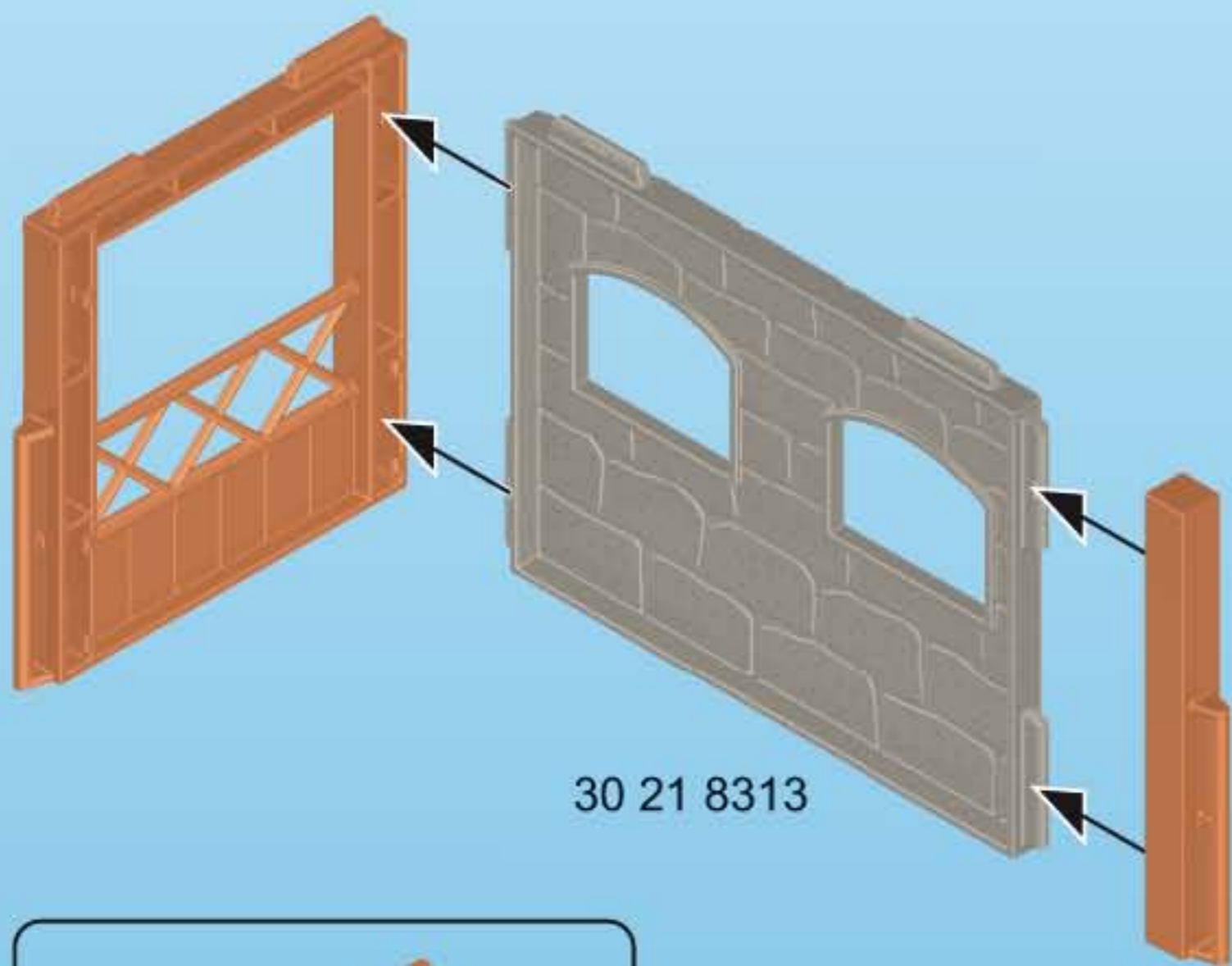

2

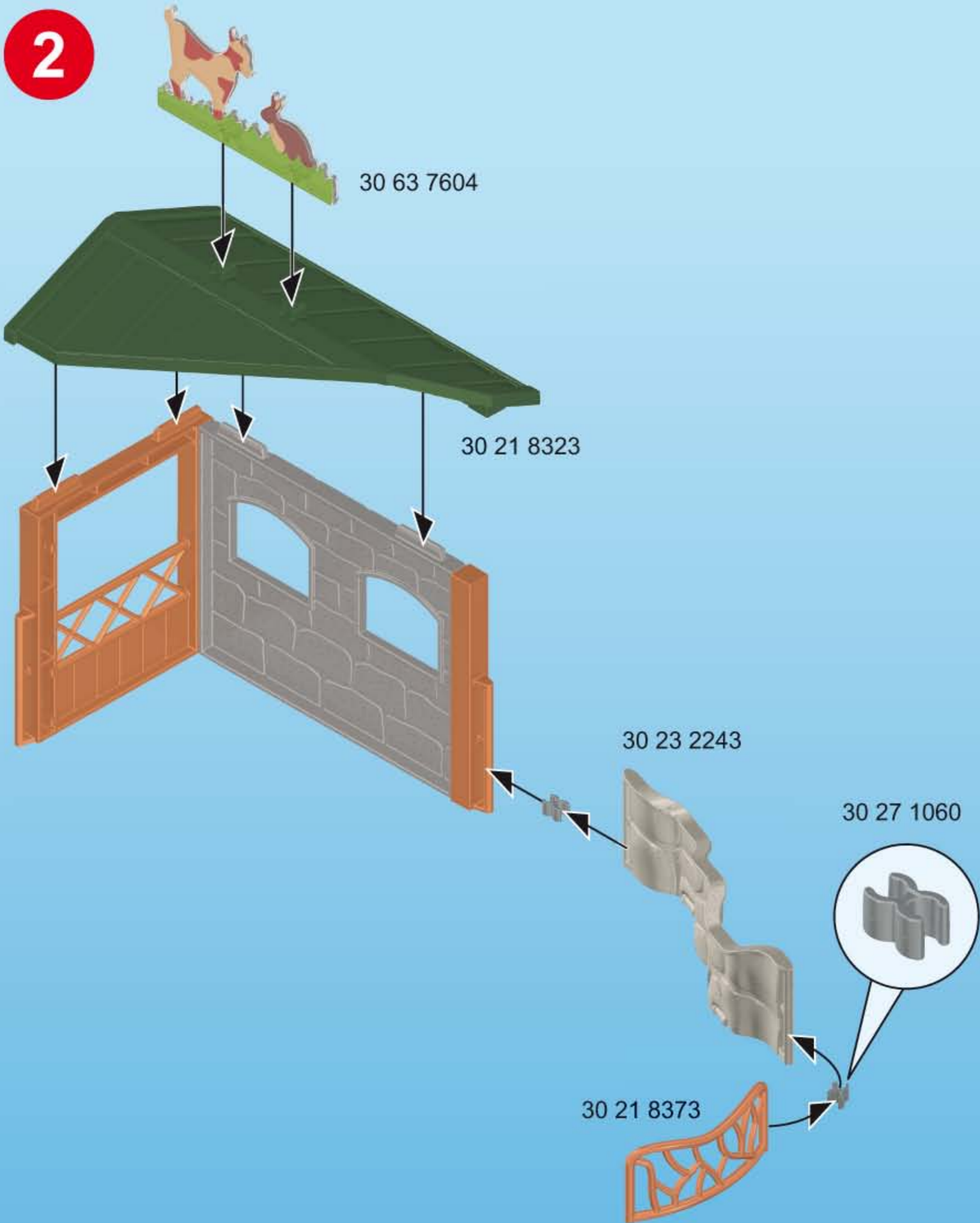

3

30 82 4653

30 21 8303

30 29 2960



4

30 22 0773  
30 22 0783



3x

30 21 8363

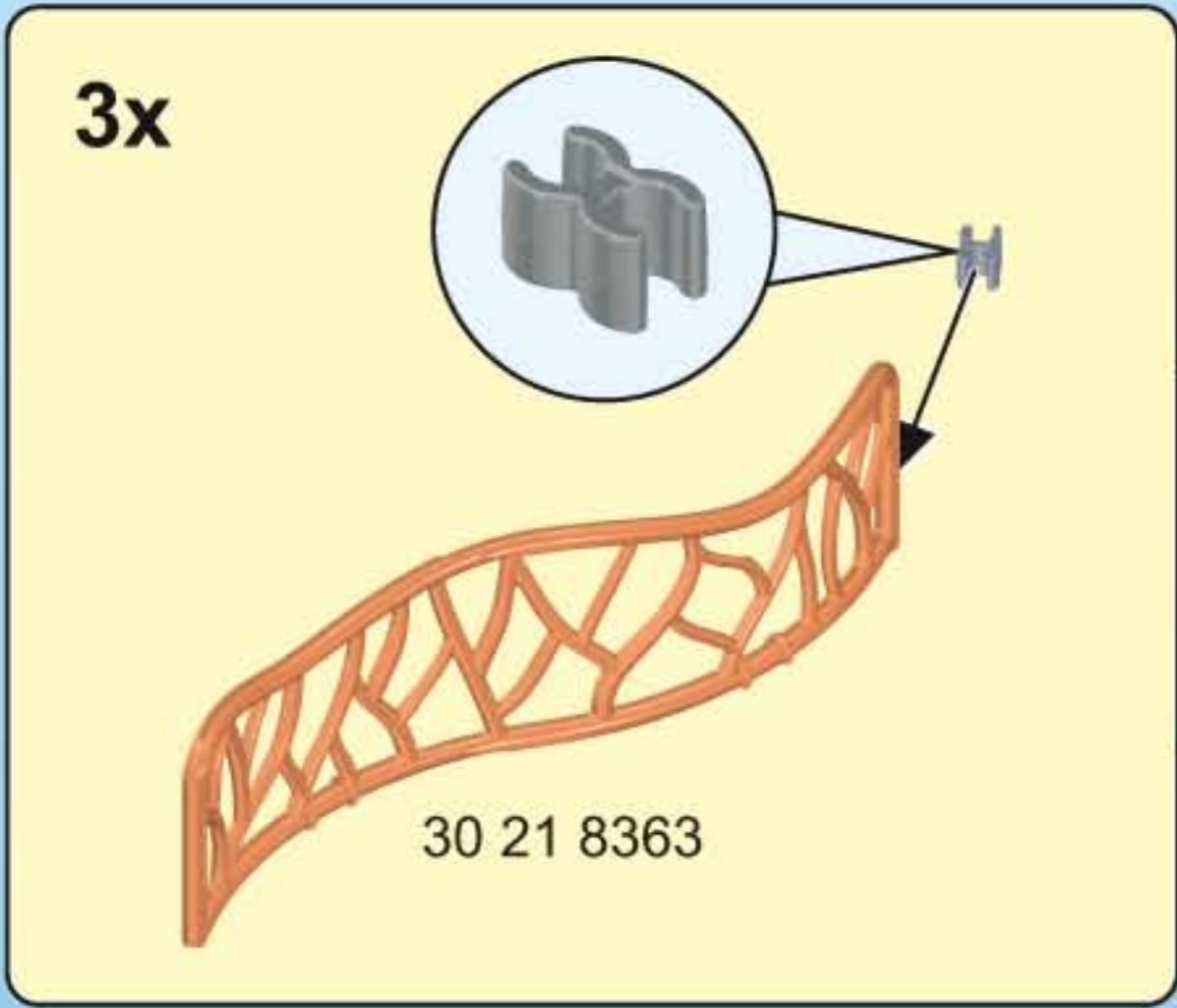

30 21 8353

30 21 8343

30 24 1352

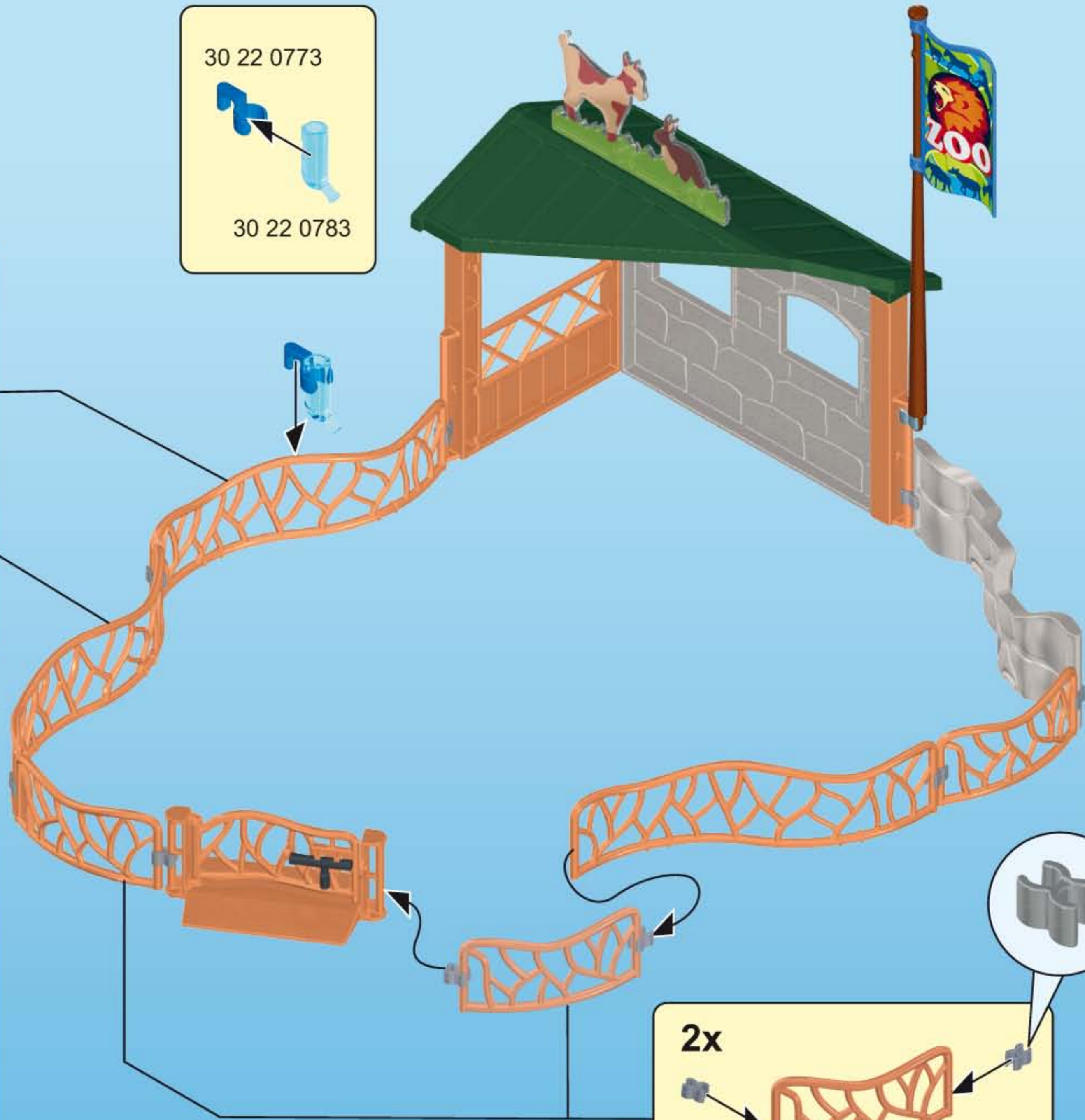
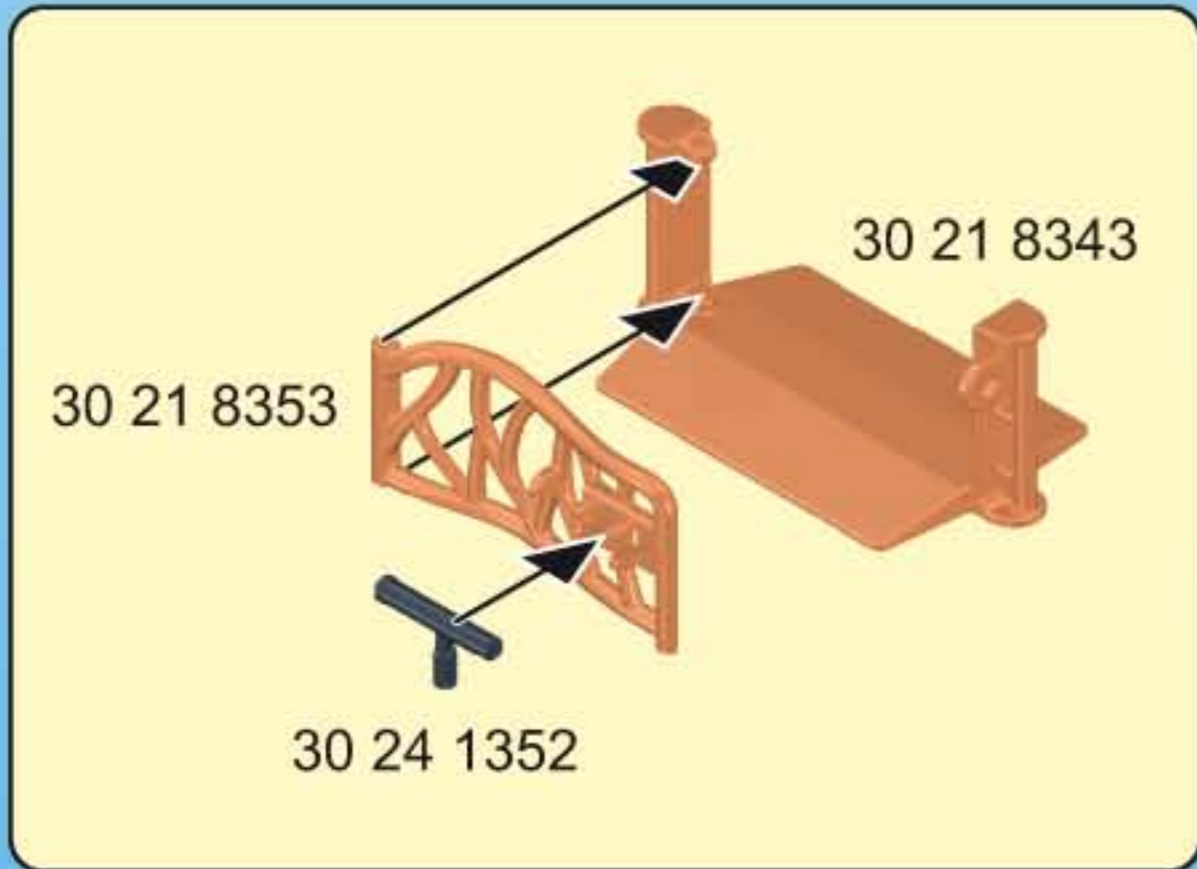

2x

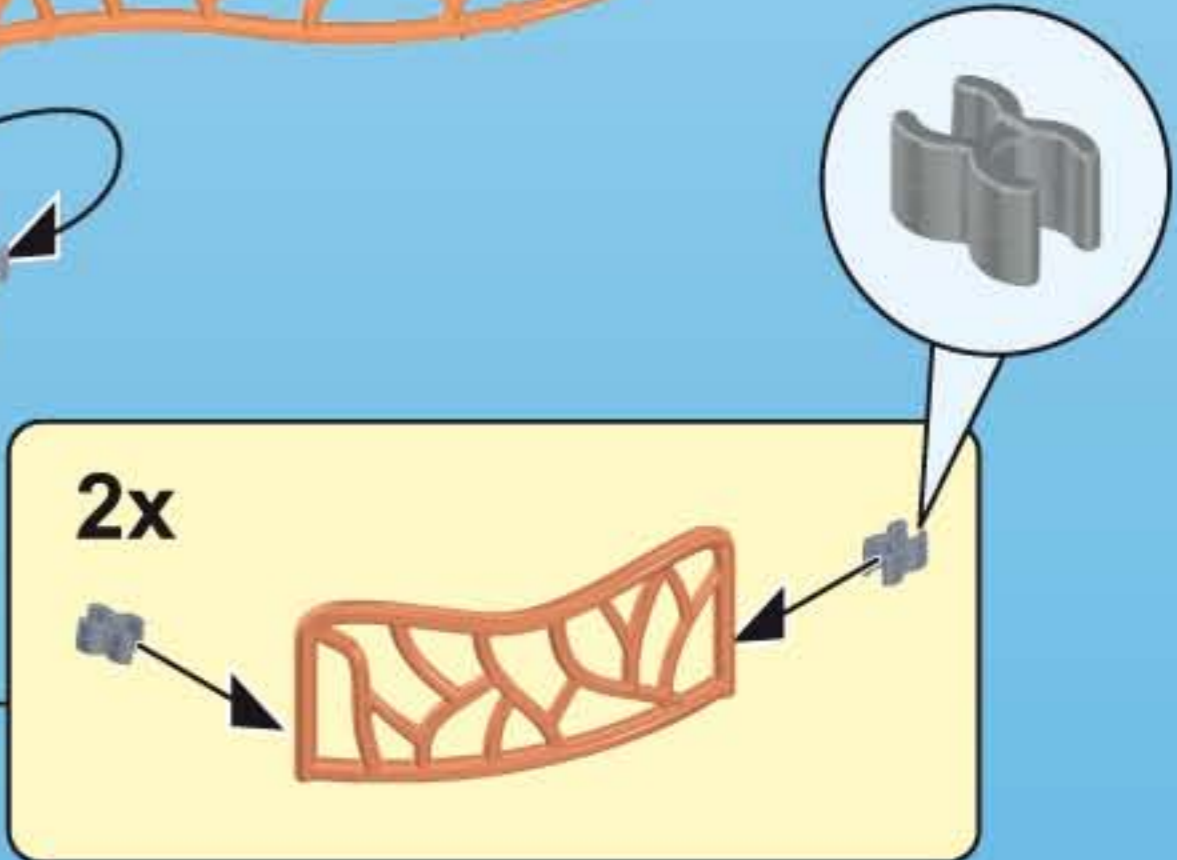

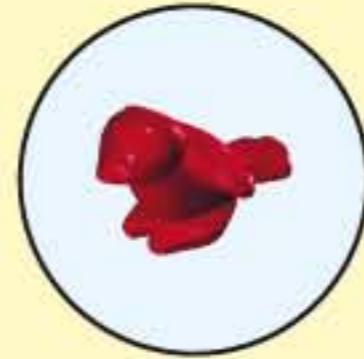
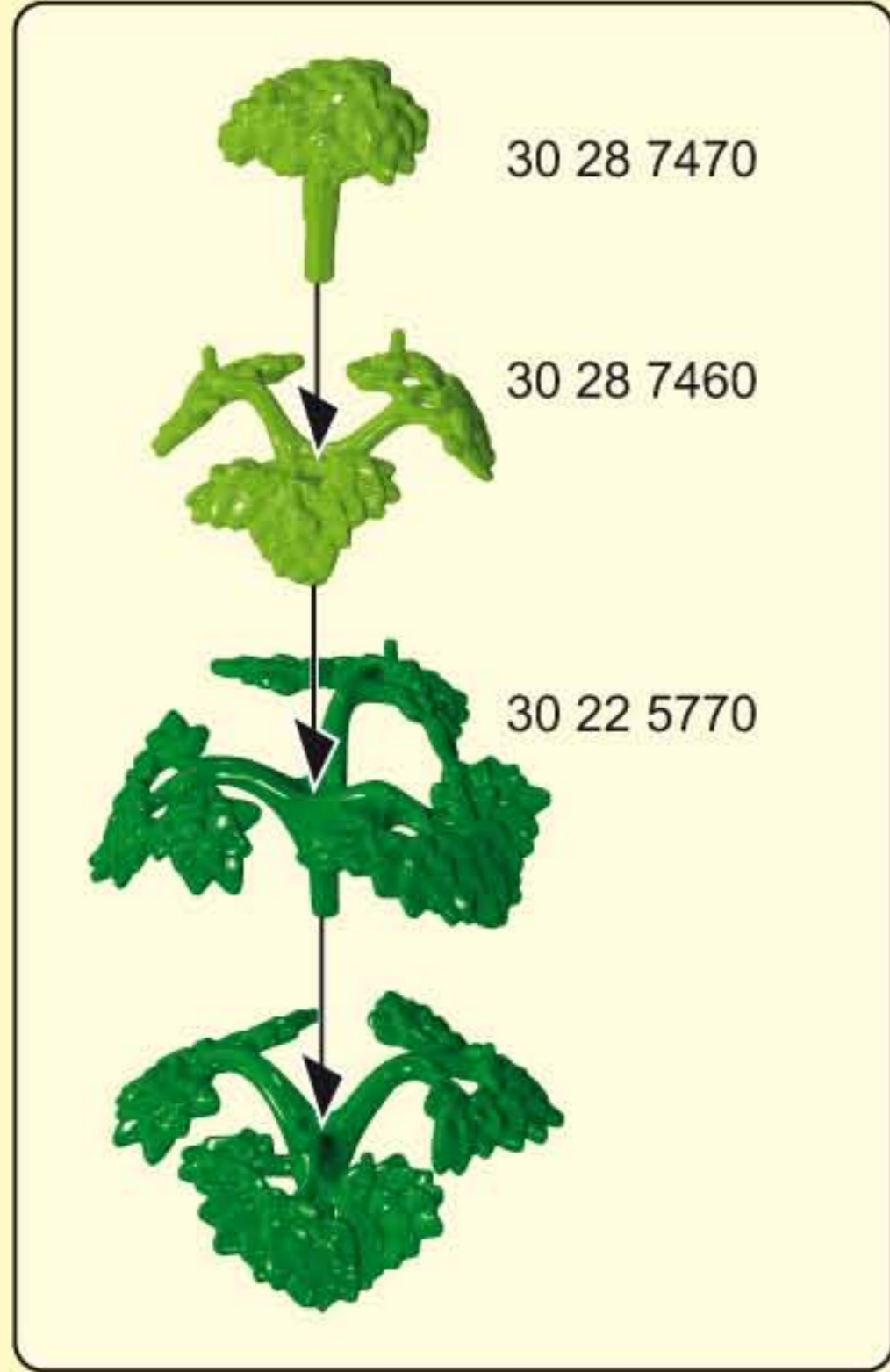

30 26 0380



30 26 0570

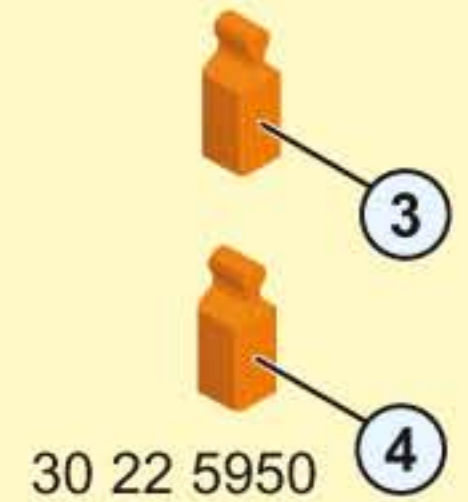
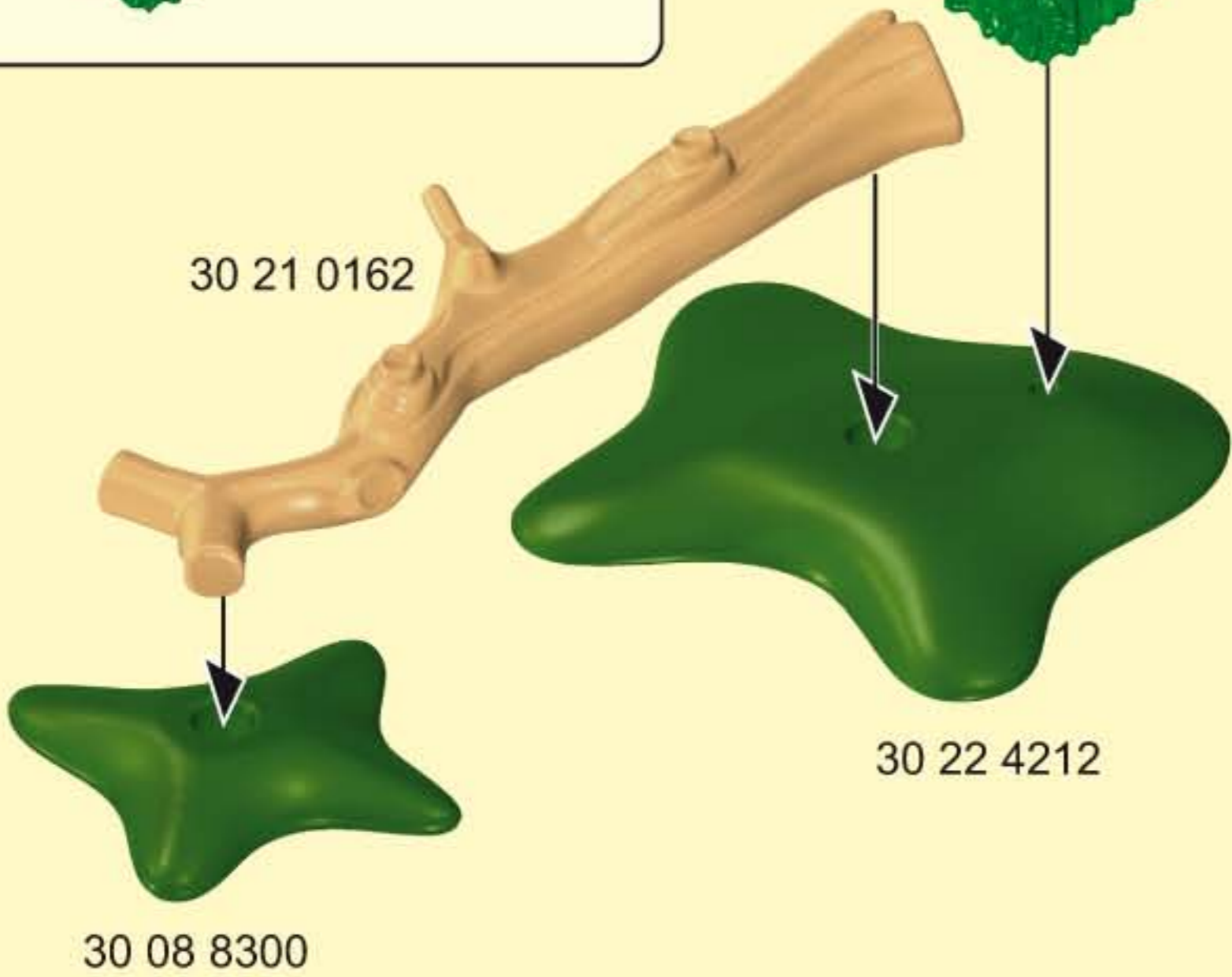



30 07 3400



30 14 7490

30 06 0340



30 11 2940



30 14 7500



30 10 3450



30 27 6910



30 28 4370



2x 30 25 6070



30 23 6150



30 66 3372



30 66 3362



30 25 4973



30 09 6060



30 65 2303



30 66 7272



30 64 3423



30 65 1643



30 65 2313



30 65 1823



30 62 6093



30 62 6113



30 83 0170



30 83 0150



30 07 4310



www.playmobil.com

© 2014 geobra Brandstätter GmbH & Co.KG  
Brandstätterstr. 2-10  
90513 Zirndorf, Germany.  
No. 30 82 6403 10.14

# 6669 Parc aquatique avec toboggans géants







# playmobil®

6669



## WARNING: CHOKING HAZARD

Contains a small ball and small parts.  
Not for children under 3 years.

"Ne concerne que les USA"

Wichtige Unterlagen, bitte sorgfältig aufbewahren!  
Important: Please keep these instructions for future reference!  
Documents importants, à conserver soigneusement!  
Belangrijke documenten, bewaar deze zorgvuldig!

Serviceadressen finden Sie in allen Playmobil-Prospekten

Addresses of Customer Service Departments are shown in all Playmobil catalogues

L'adresse du service consommateurs est indiquée dans tous les catalogues Playmobil

Troverete gli indirizzi dei centri di assistenza in tutti i cataloghi Playmobil

In alle PLAYMOBIL catalogi vindt u het adres van onze klantendienst.

Las Direcciones de los Departamentos de Servicio al Consumidor se encuentran en todos los catálogos Playmobil

Η διεύθυνση του Γραφείου Εξυπηρέτησης Καταναλωτών PLAYMOBIL βρίσκεται σε όλους τους καταλόγους PLAYMOBIL.

pronounce: plāy-mō-bēēl



1

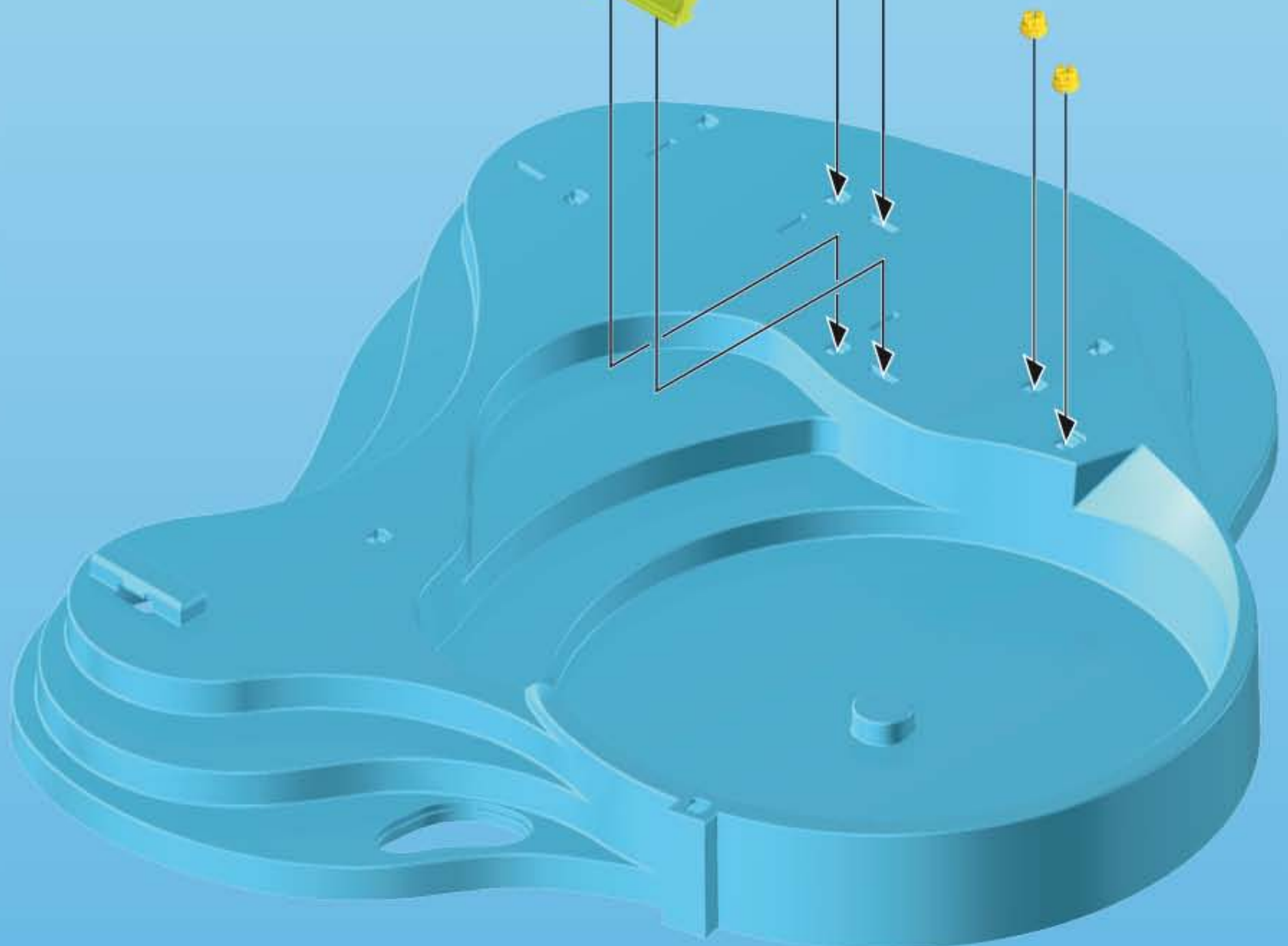
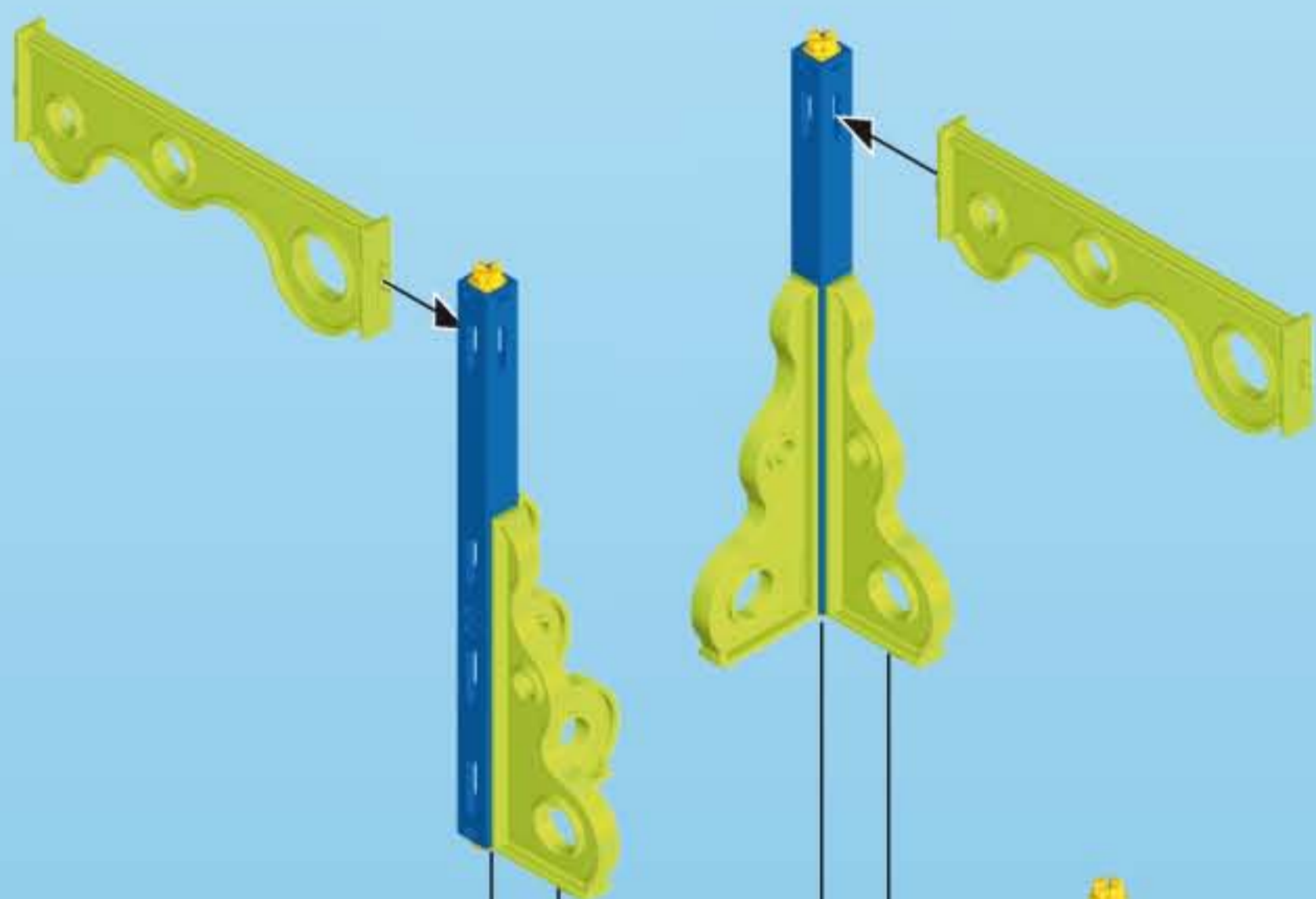
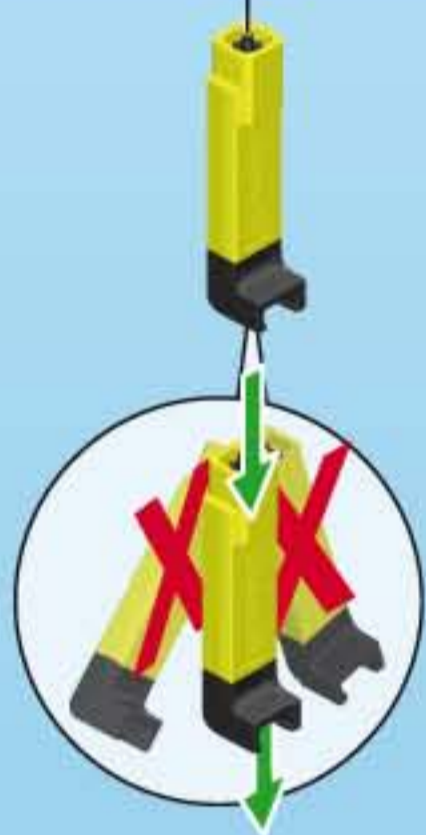
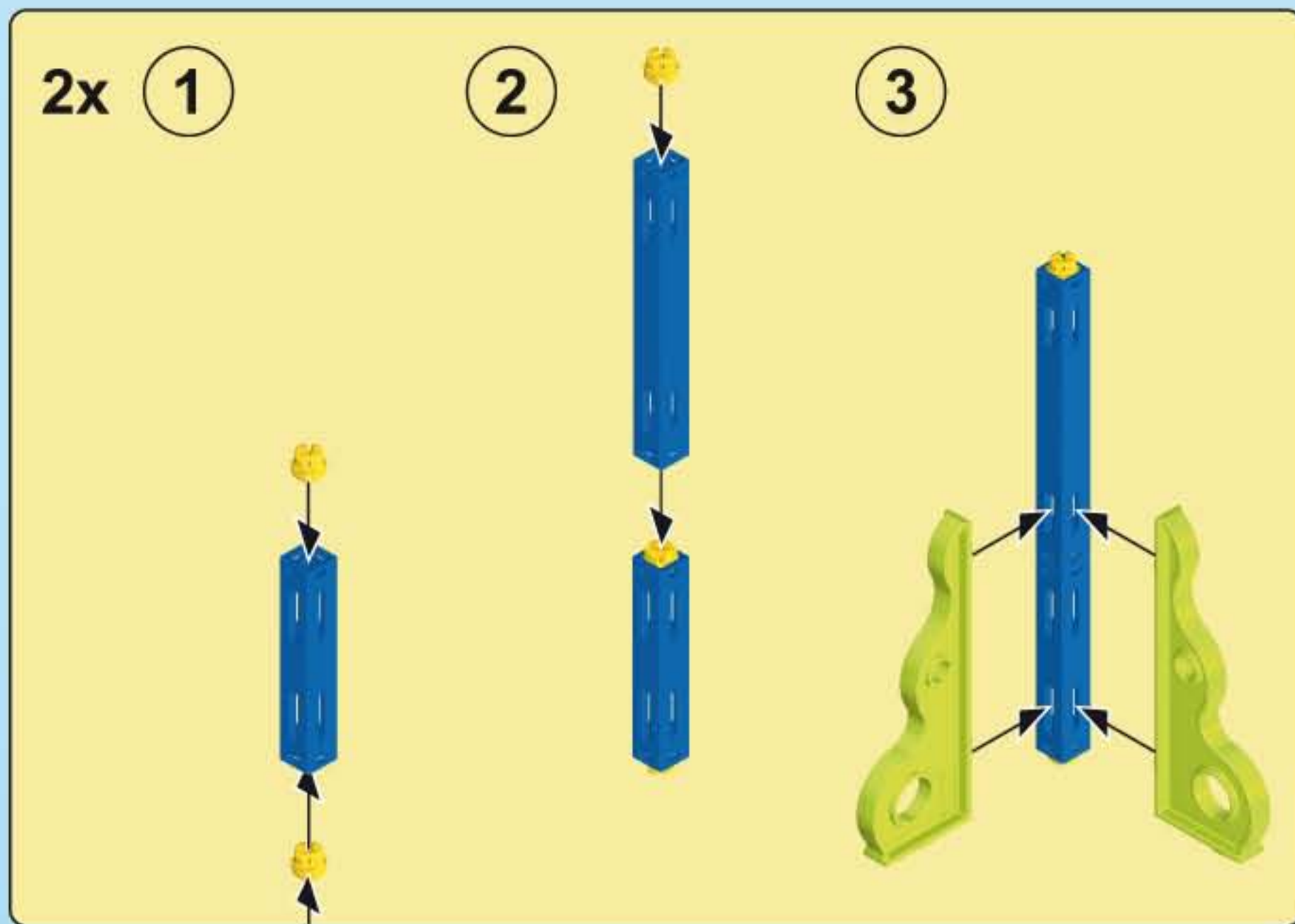

2

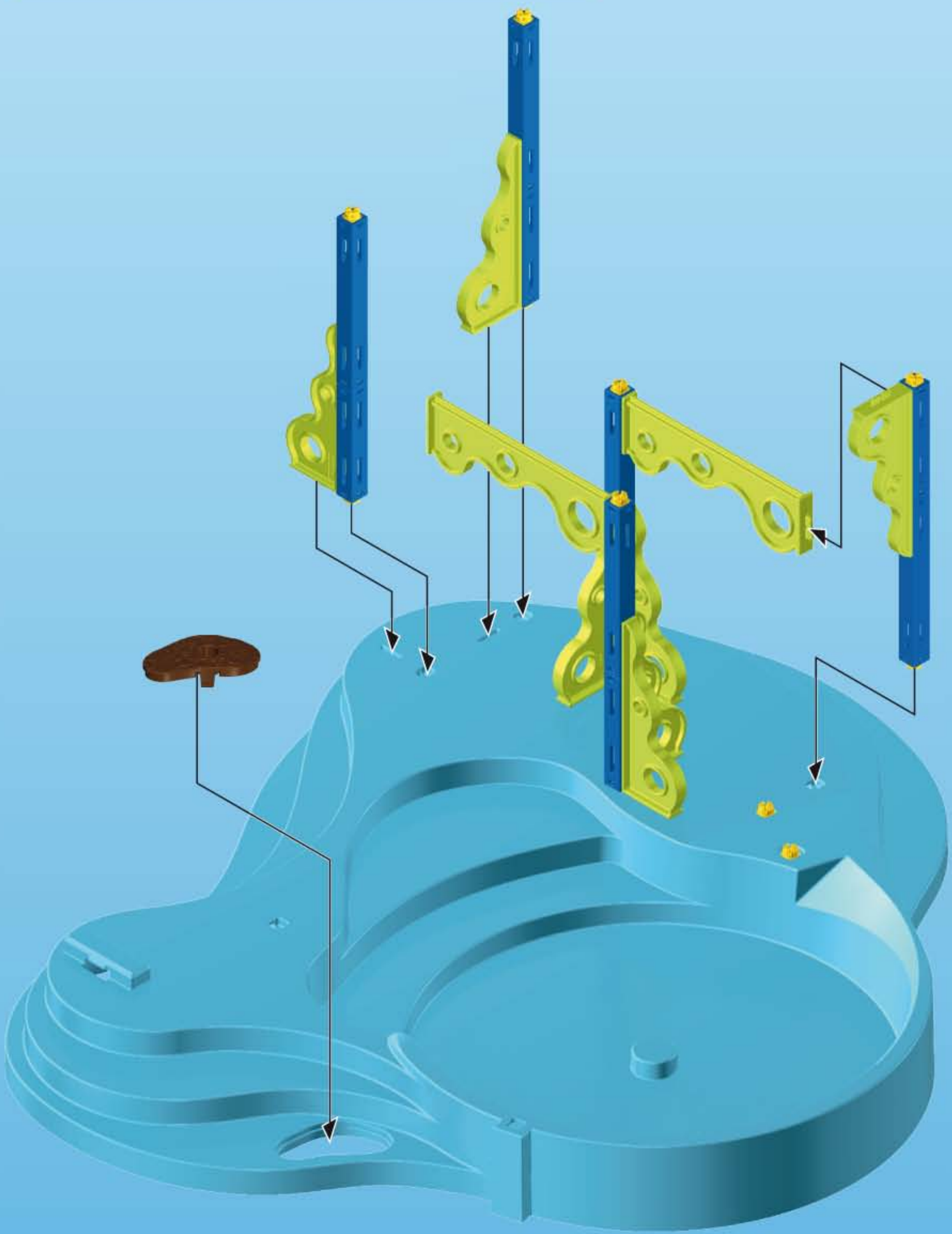
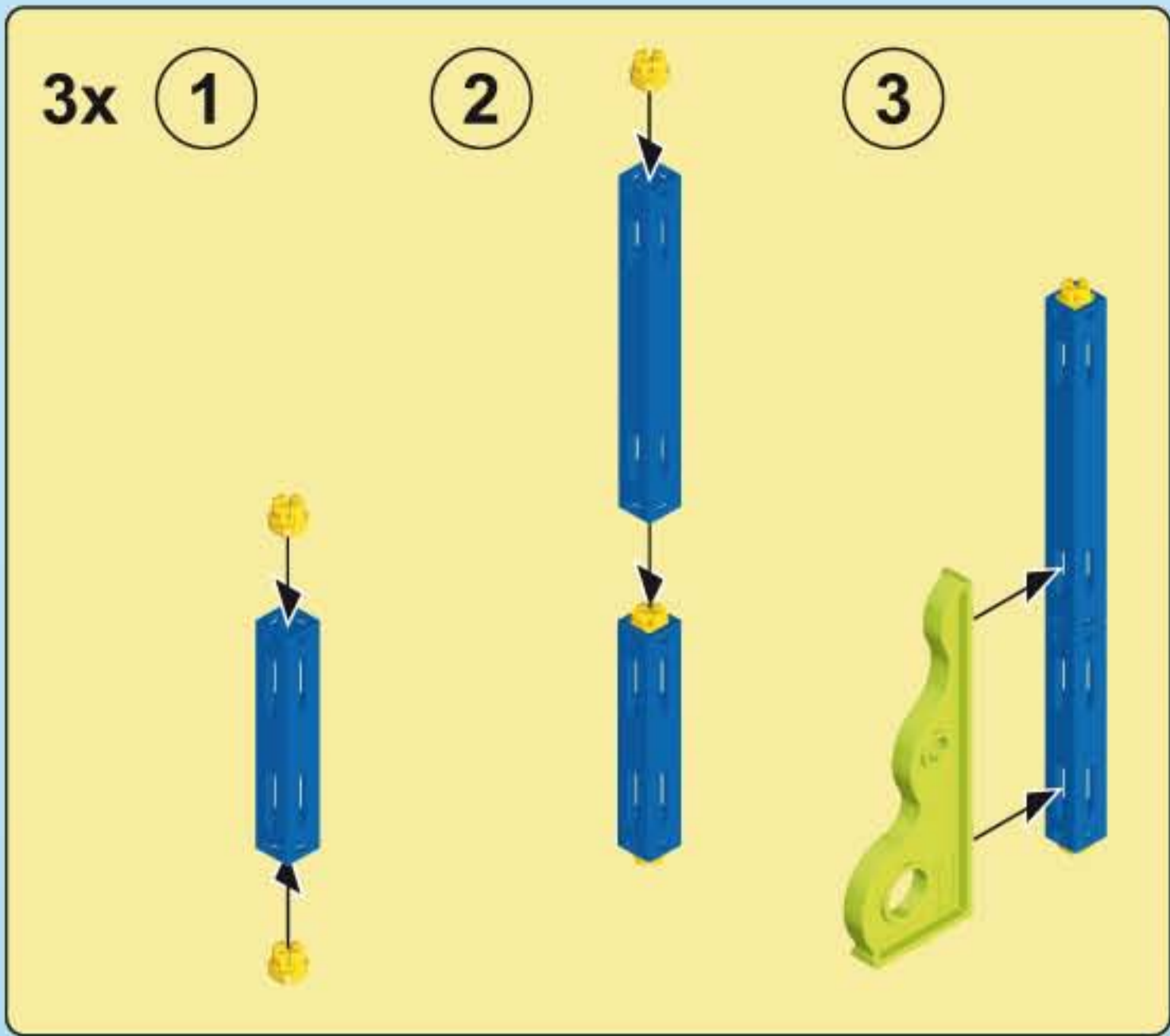

3

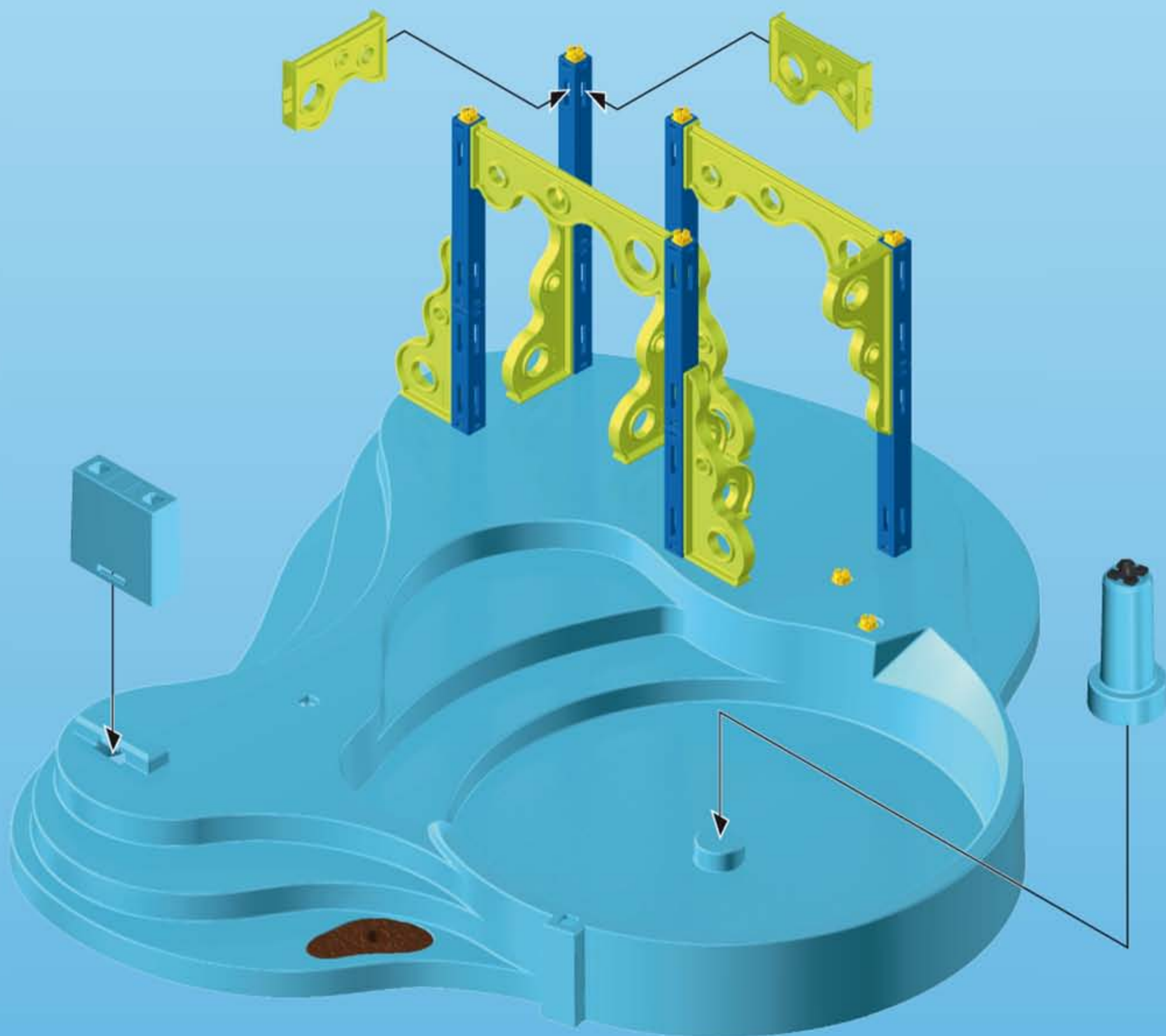
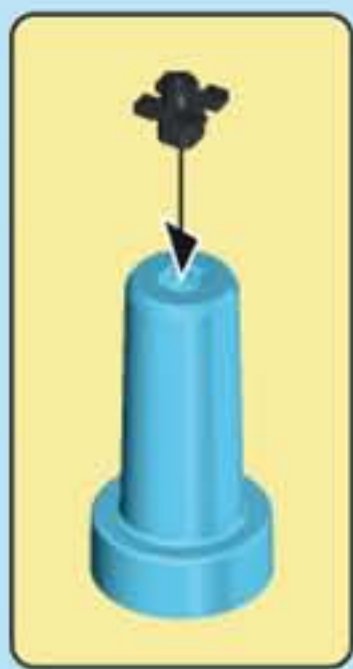



4

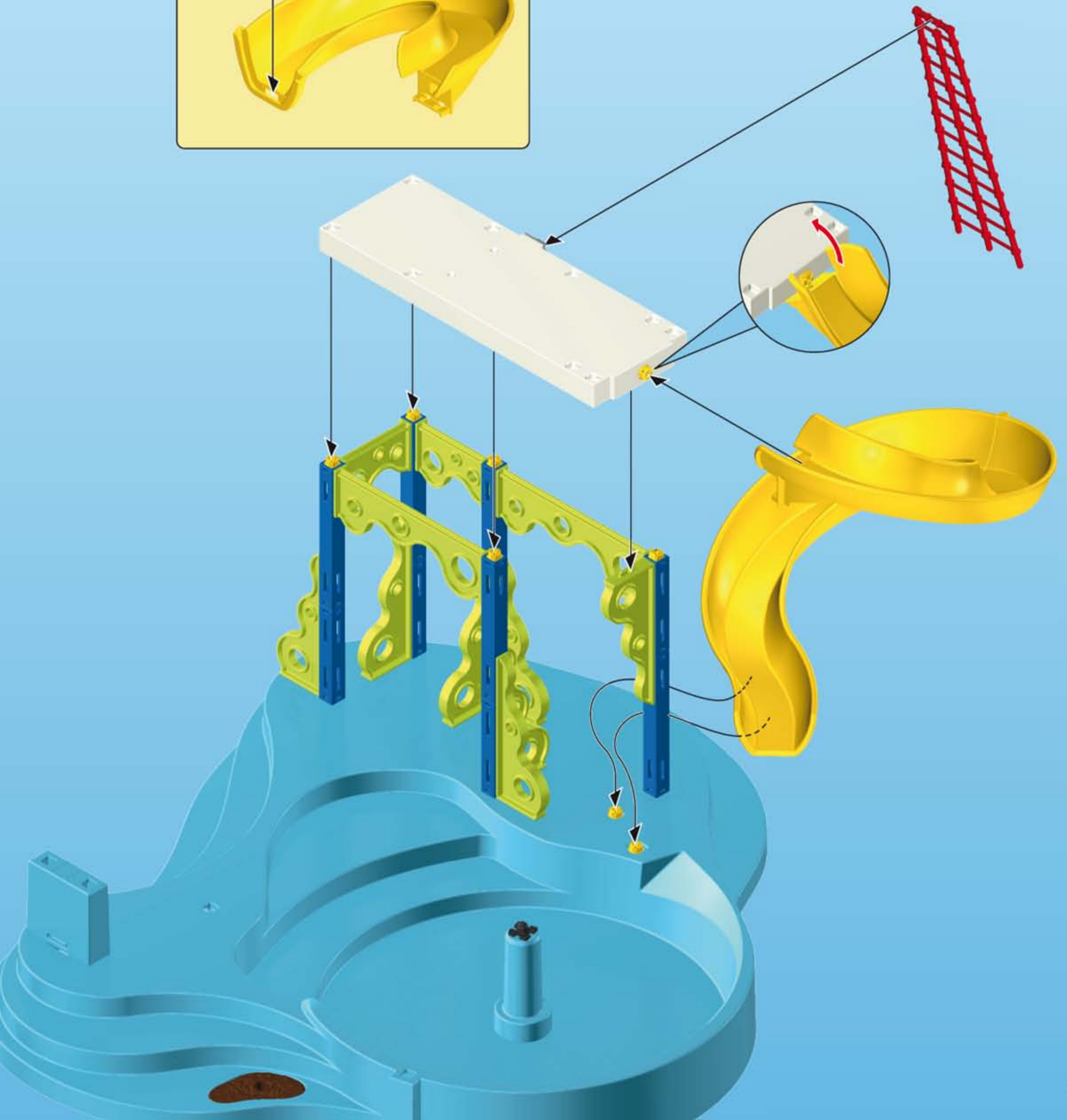
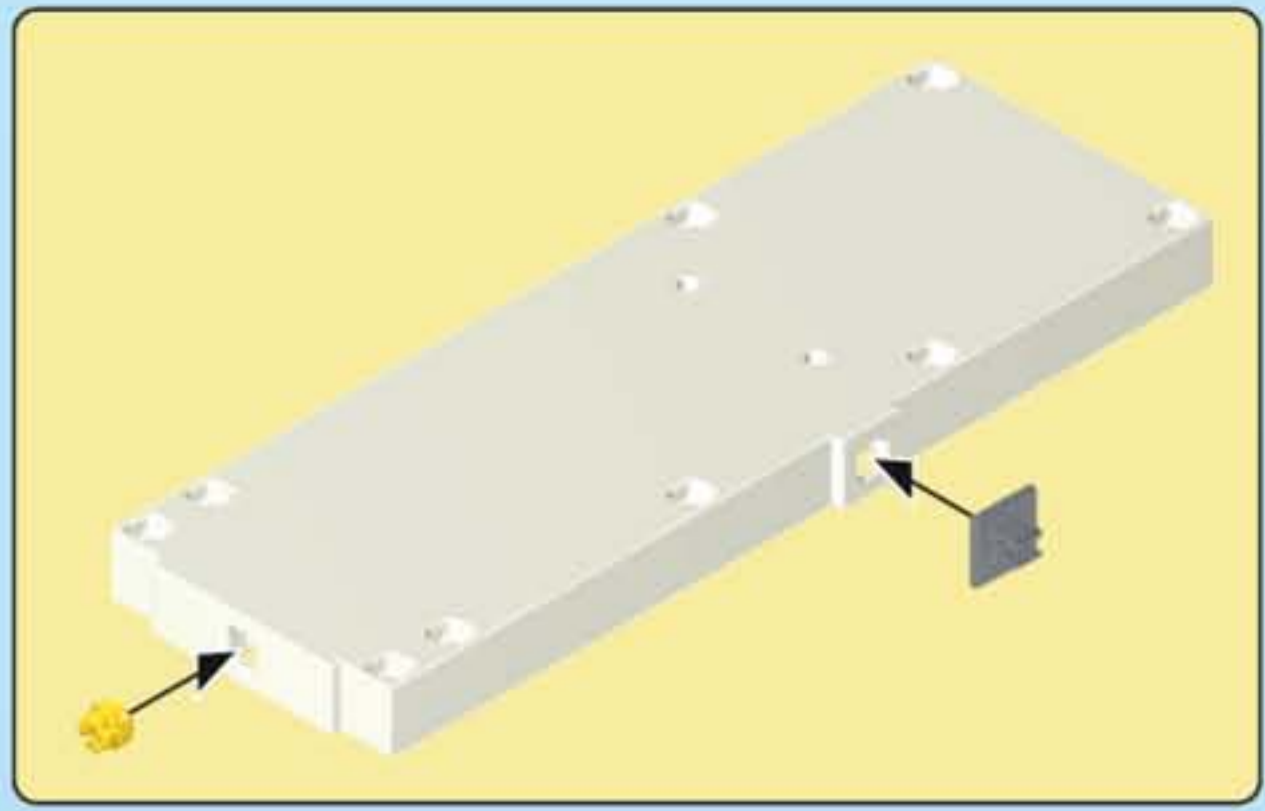

5

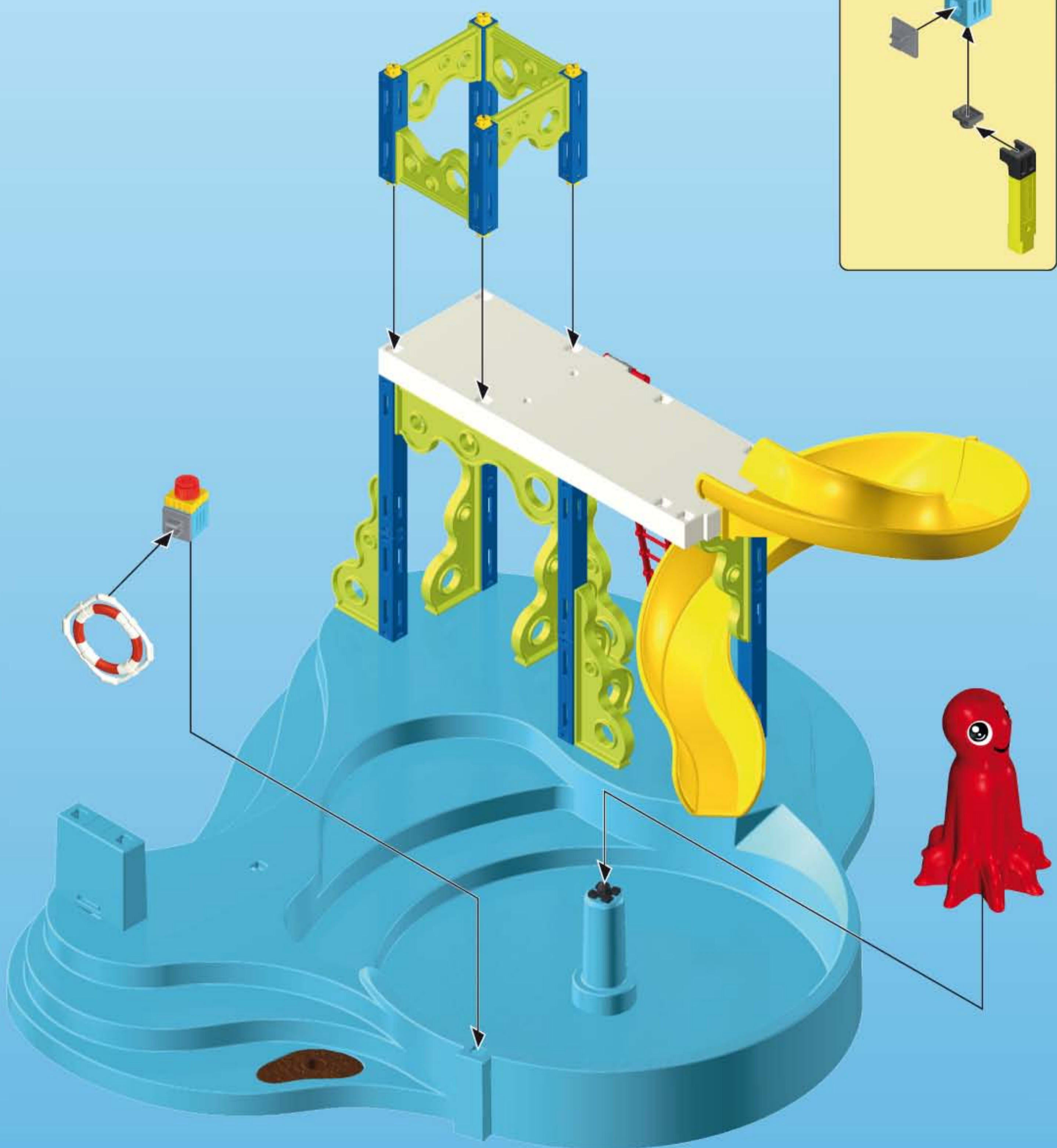
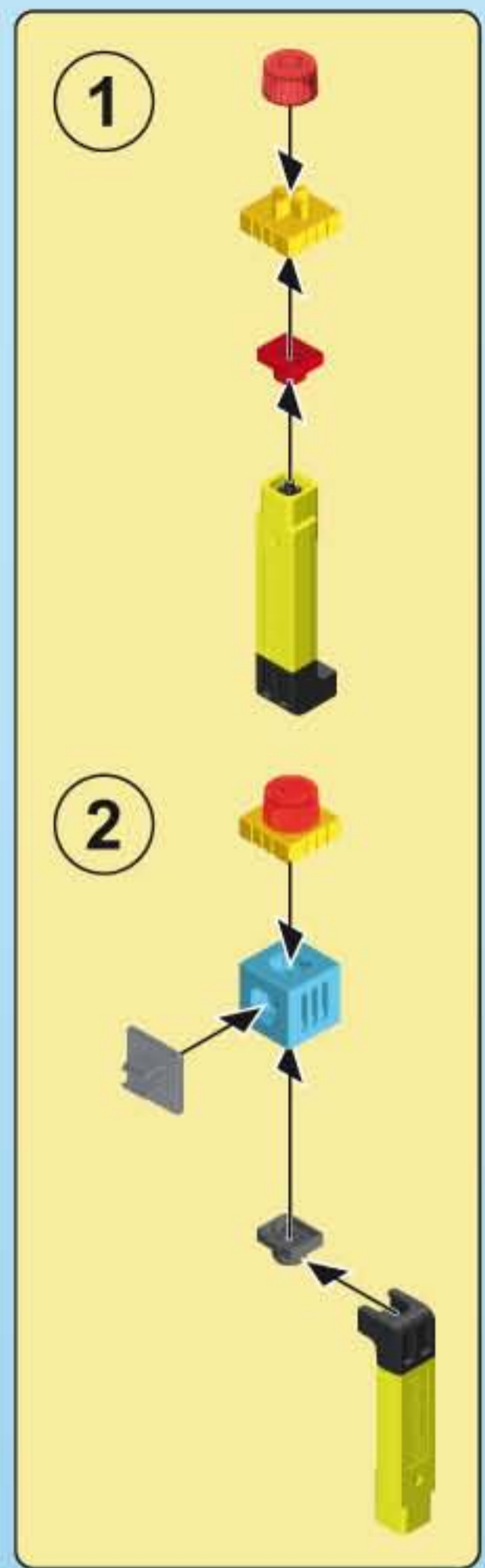
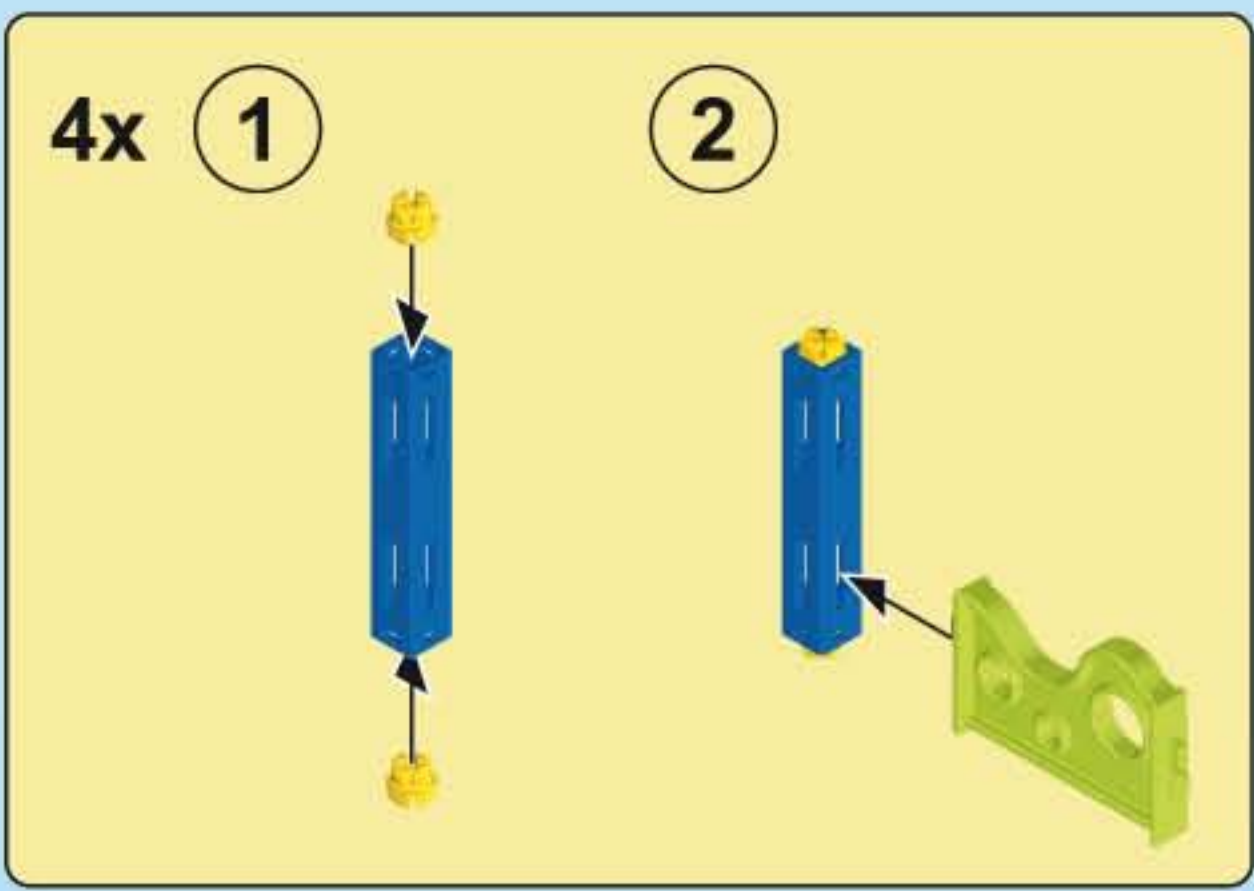

6

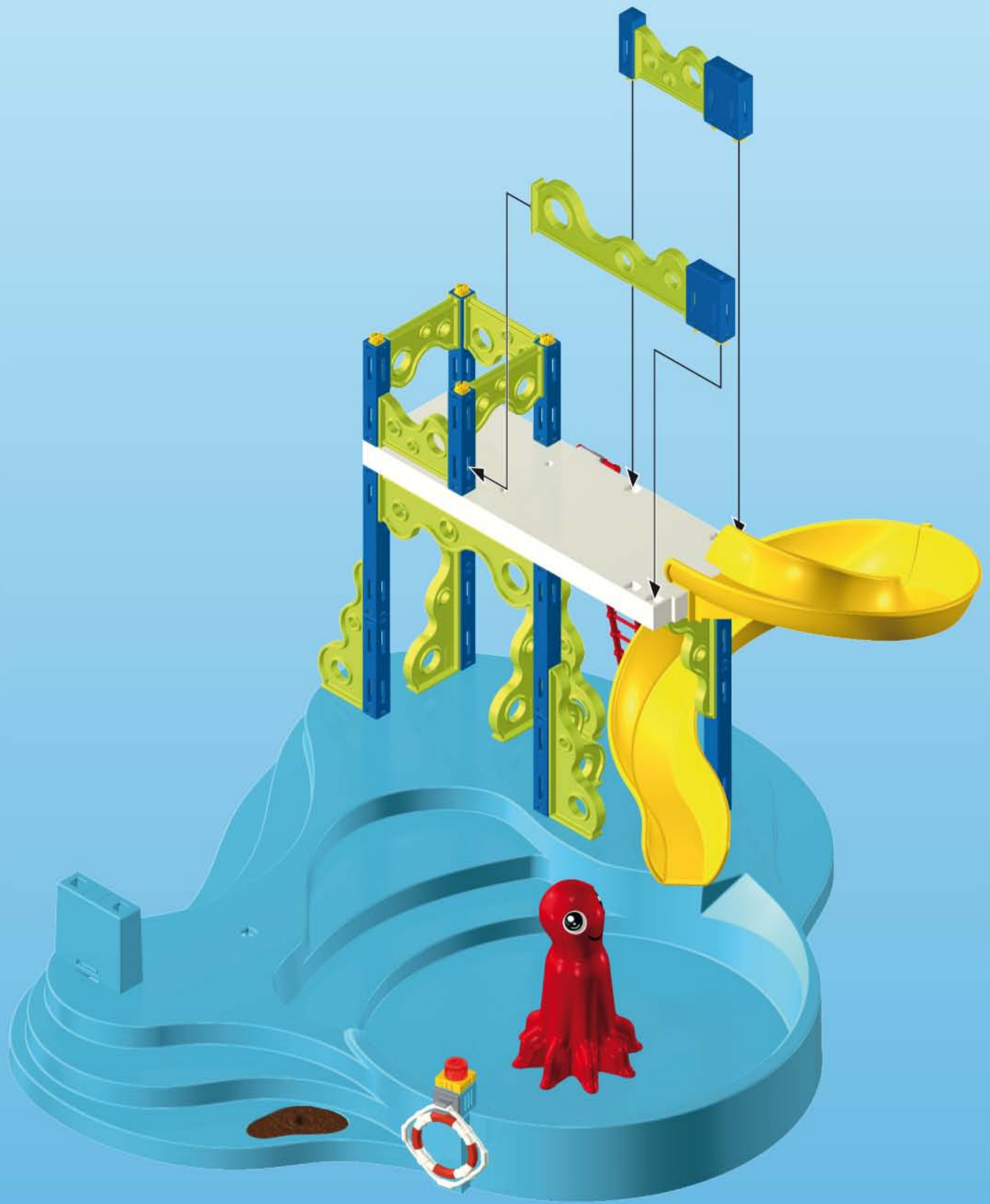
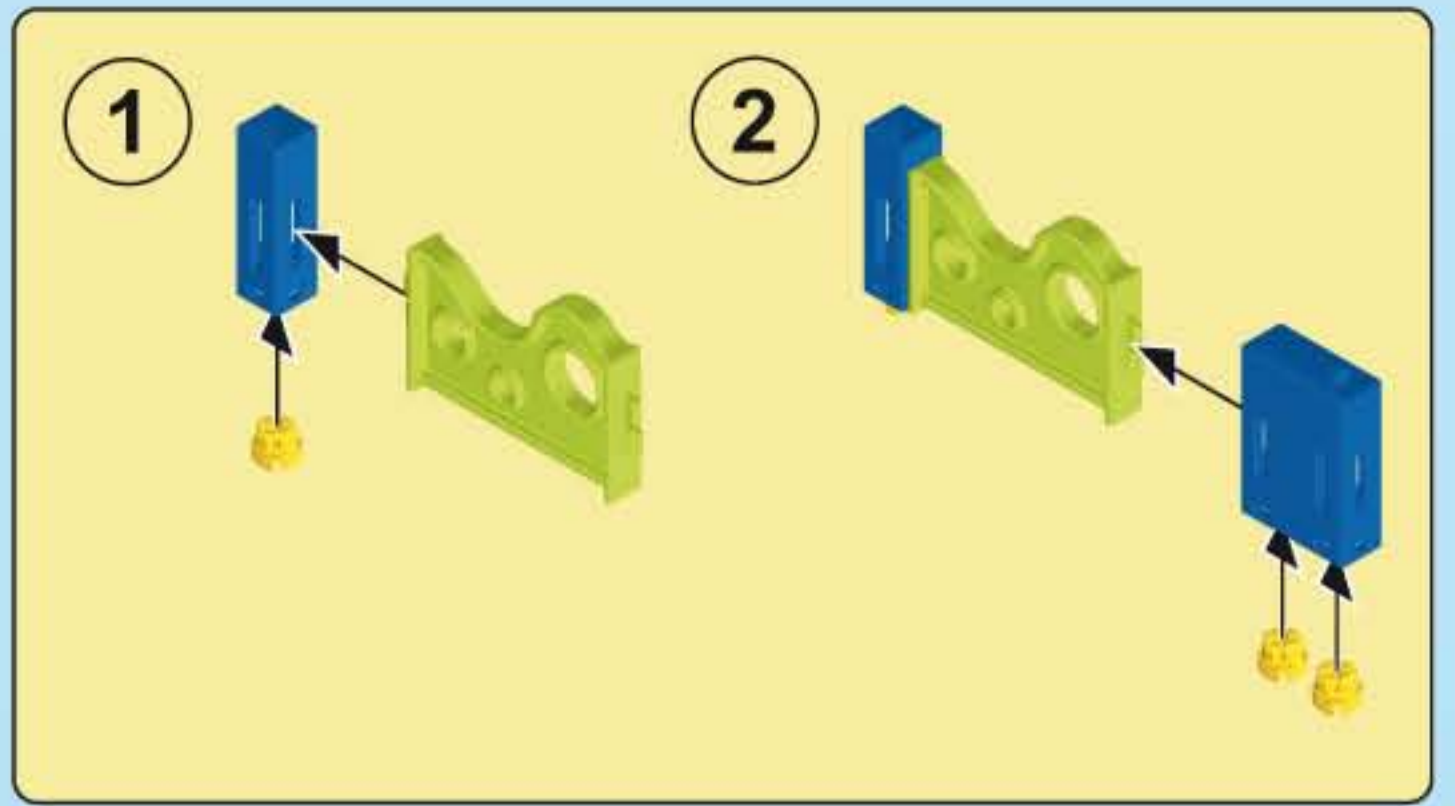
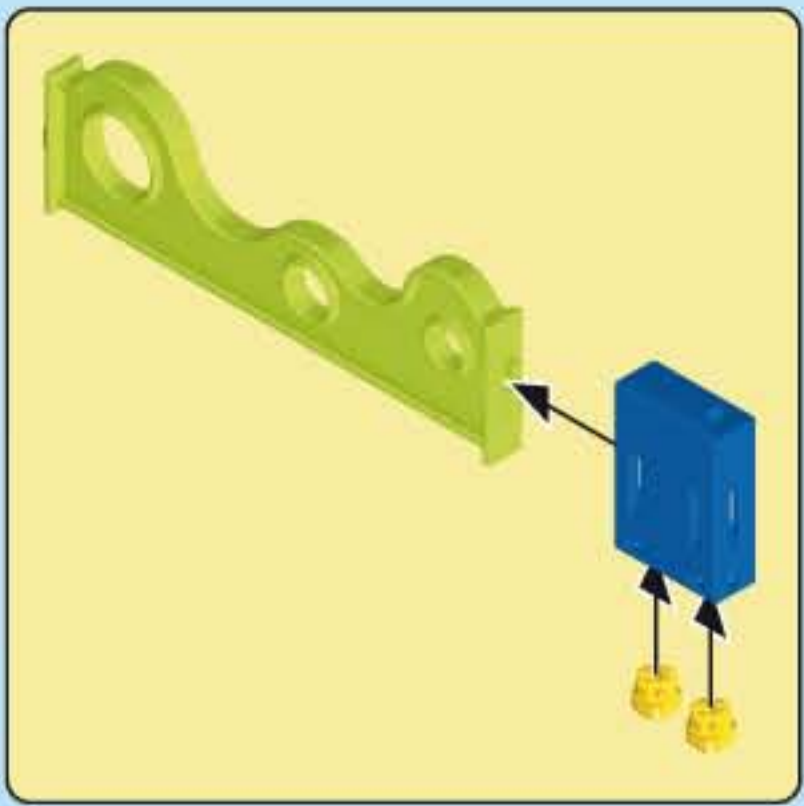

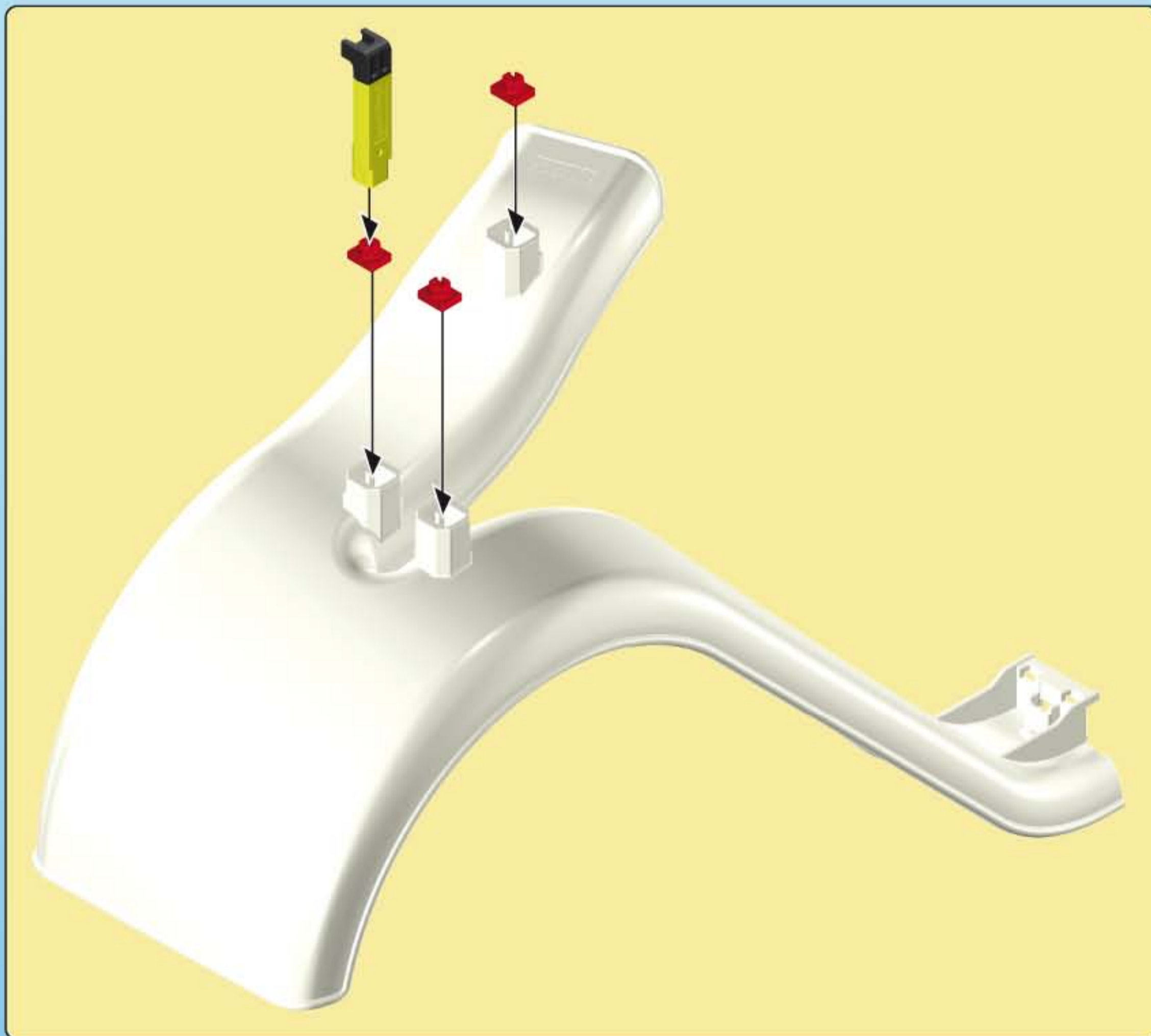
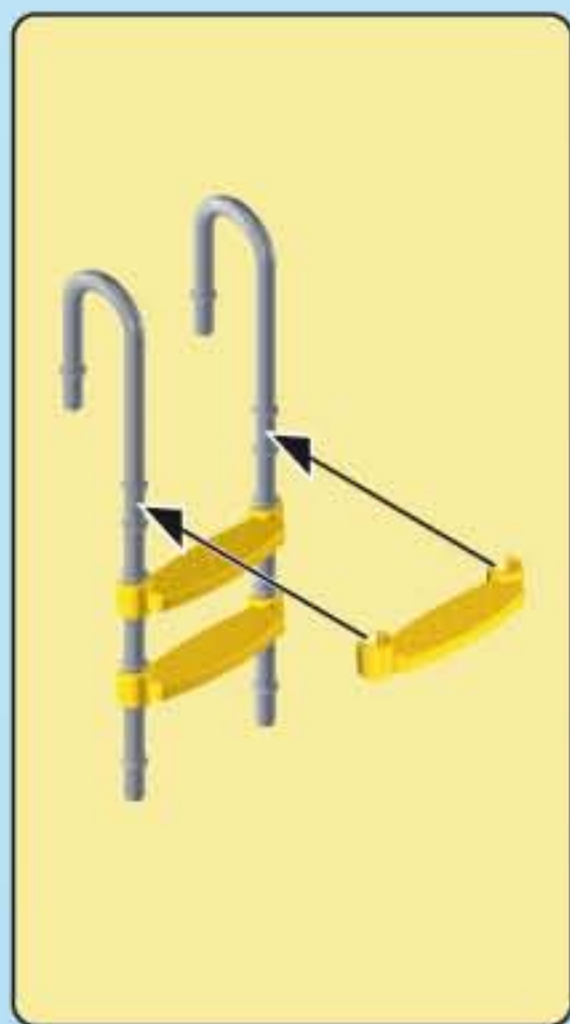
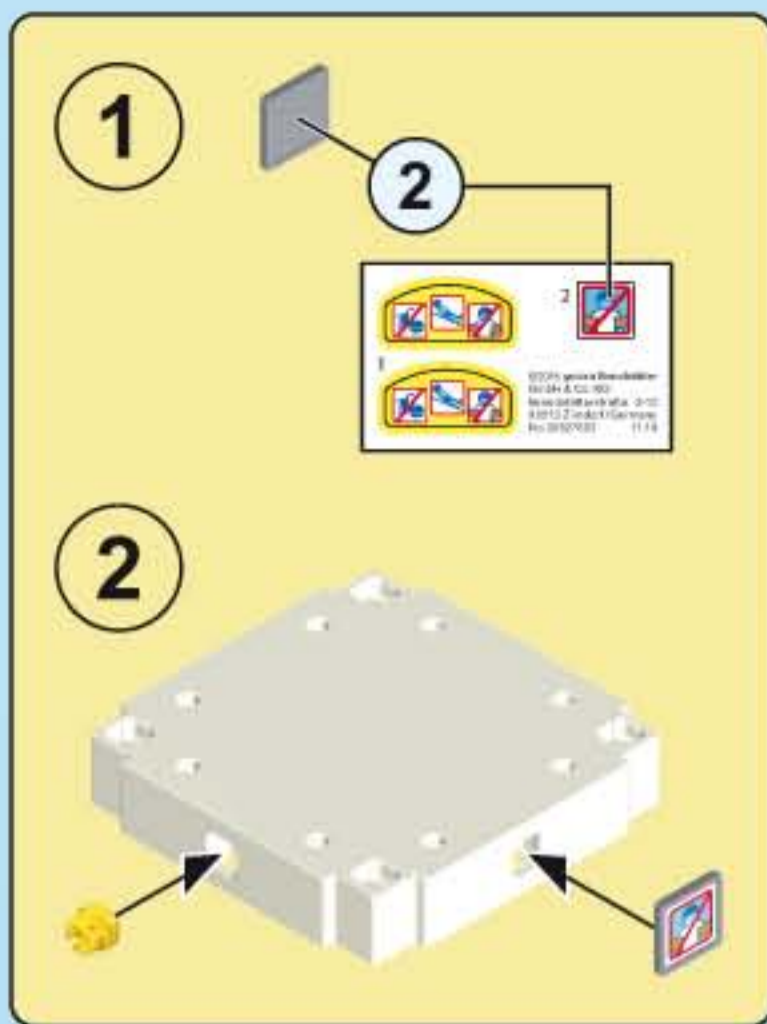

7

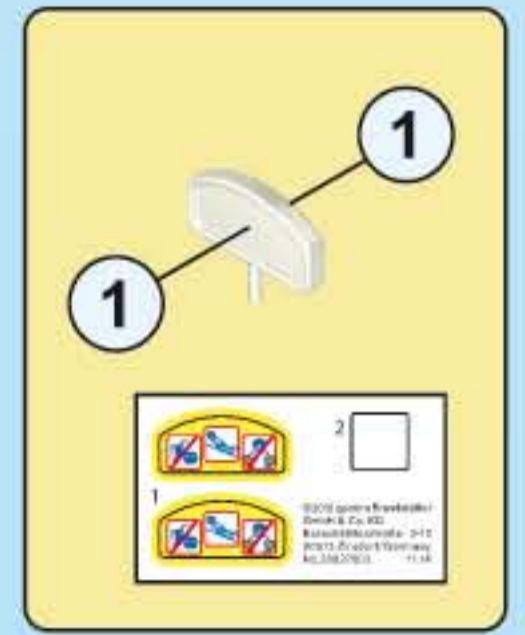
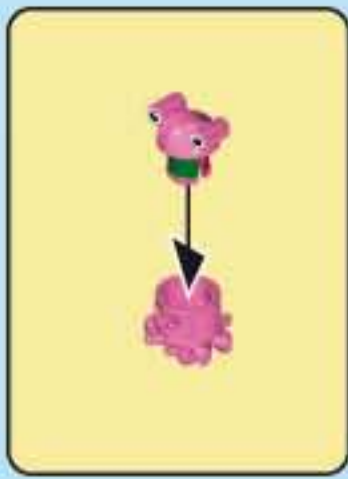

8

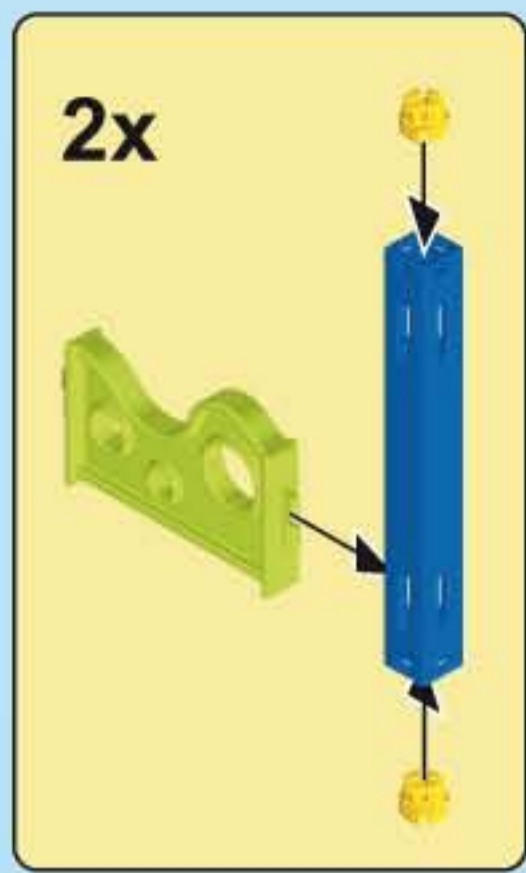

9

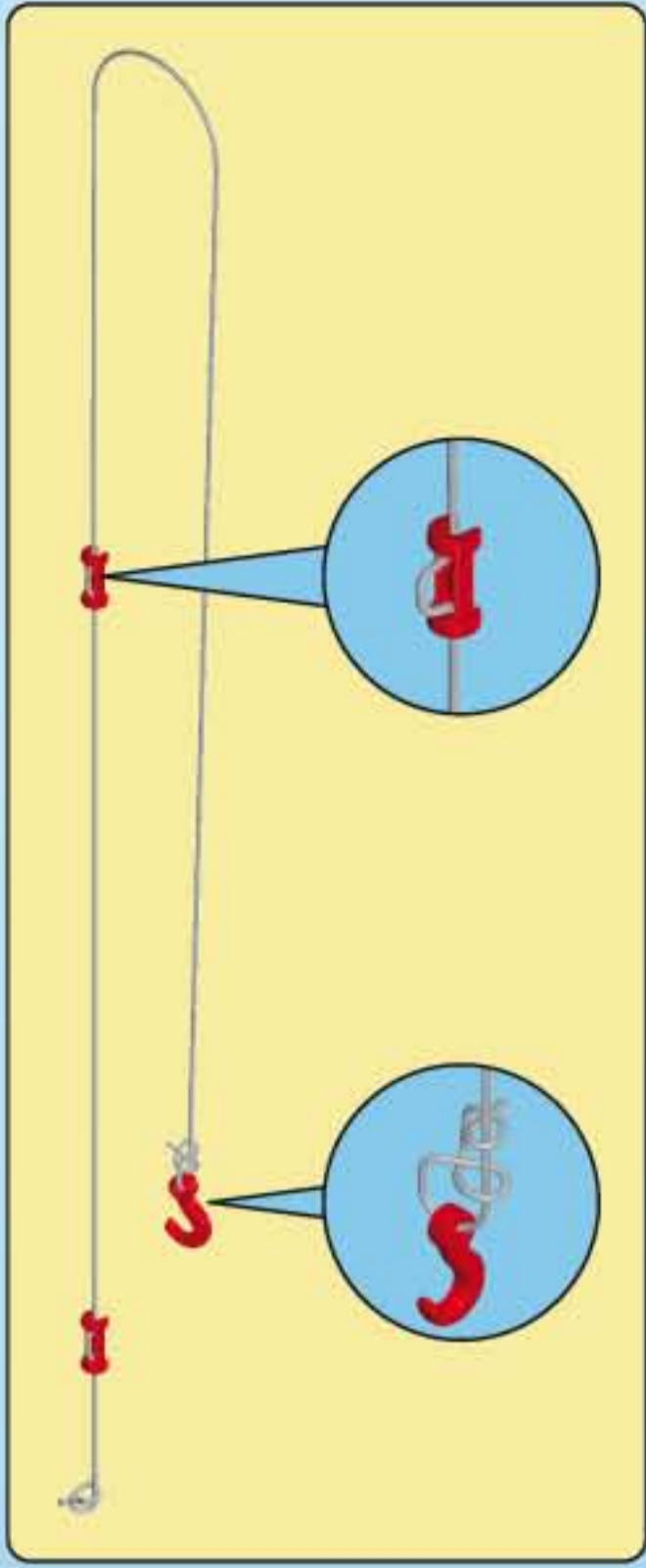

10

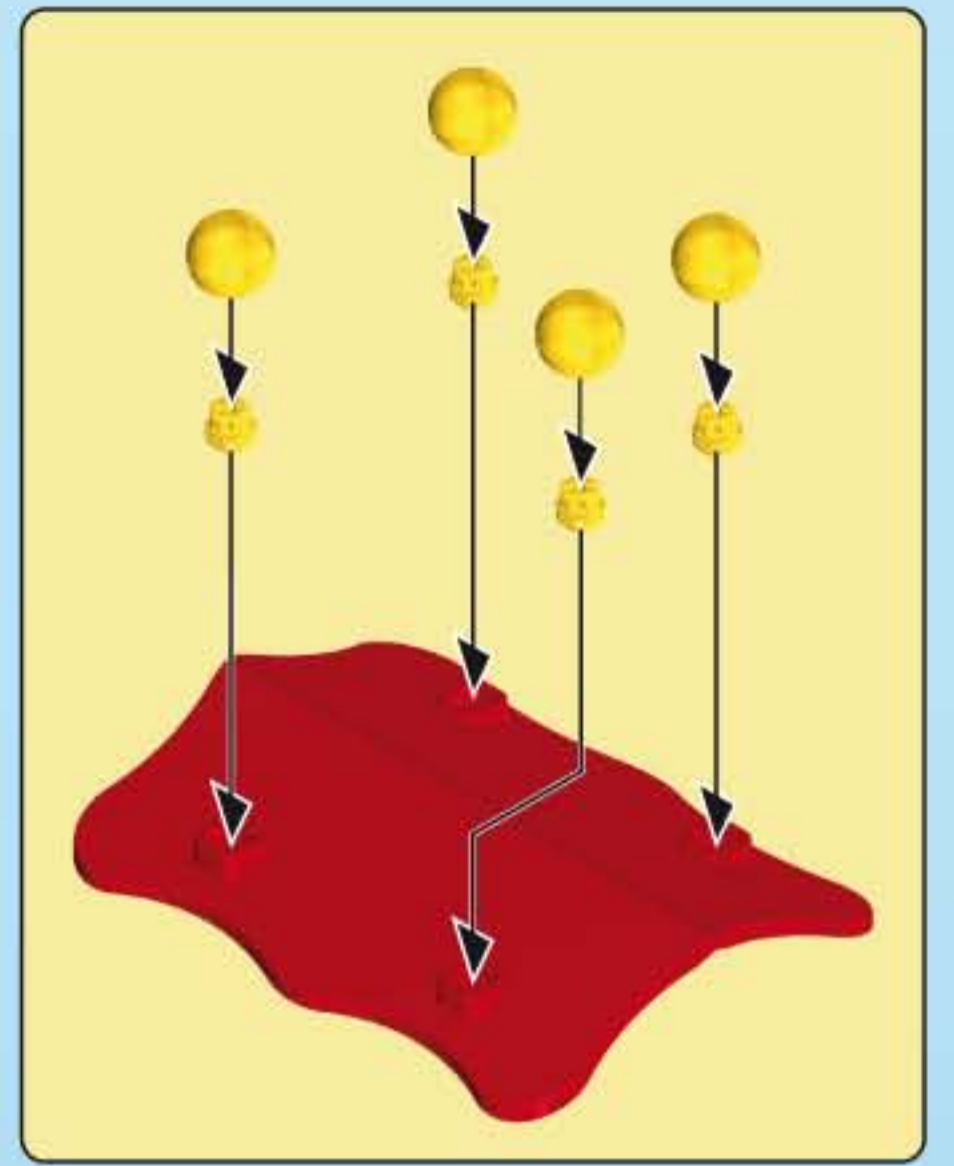



**D A CH L B** Nur Trinkwasser verwenden. Nach dem Spielen austrocknen lassen.

**USA GB CDN M IRL** Use only tap water. Dry thoroughly after play.

**F CDN B L CH** N'utiliser que de l'eau potable. Faire sécher après chaque utilisation.

**E MEX** Utilizar solamente agua potable. Dejar secar antes de guardar.

**NL B** Enkel drinkbaar water gebruiken. Na het spelen laten drogen.

**I CH** Usare solo acqua potabile. Asciugare bene dopo ogni uso.

**P** Utilizar somente água potável. Deixar secar antes de guardar.

**DK** Anvend kun drikkevand. Lad det tørre ud når du er færdig med at lege.

**N** Kun drikkevann skal benyttes. Tørk opp etter at leken er ferdig.

**S FIN** Använd endast dricksvatten. Låt torka efter användandet.

**FIN** Käytä ainoastaan juomavettä. Anna kuivua leikin jälkeen.

**H** Kérjük kizárólag ivóvizet használni! Játék után ajánlott a termék kiszáritása!

**CZ** Používat jen pitnou vodu. Po hraní nechat vyschnout.

**EST** Kasutada üksnes joogivett! Mängimise järel kuivatada!

**LV** Izmantot tikai dzeramo ūdeni. Pēc spēlēšanās ļaut nožūt.

**LT** Naudokite tik geriamąjį vandenį. Pažaidus, išdžiovinkite.

**SLO** V igračo vlivajte le pitno vodo. Po igri naj se igrača posuši.

**SK** Používať iba pitnú vodu. Po hre nechať vyschnúť.

**PL** Używaj tylko wody pitnej. Po zabawie pozostaw do wyschnięcia.

**TR CY** Sadece içme suyu kullanınız. Oyundan sonra kurumaya bırakın.

**GR CY** Χρησιμοποιείτε μόνο νερό βρύσης. Μόλις τελειώσετε, αφήστε το παιχνίδι να στεγνώσει εντελώς.

**RO** Se folosește doar apă potabilă. După joacă se lasă să se usuce.

**BG** Използвайте само питейна вода. След игра оставете да изсъхне.

**HR** Koristiti samo pitku vodu. Poslije igranja pustiti da se osuši.

**CN** 仅使用饮用水。玩耍后要干燥。





3x 30 23 5503



30 23 5473

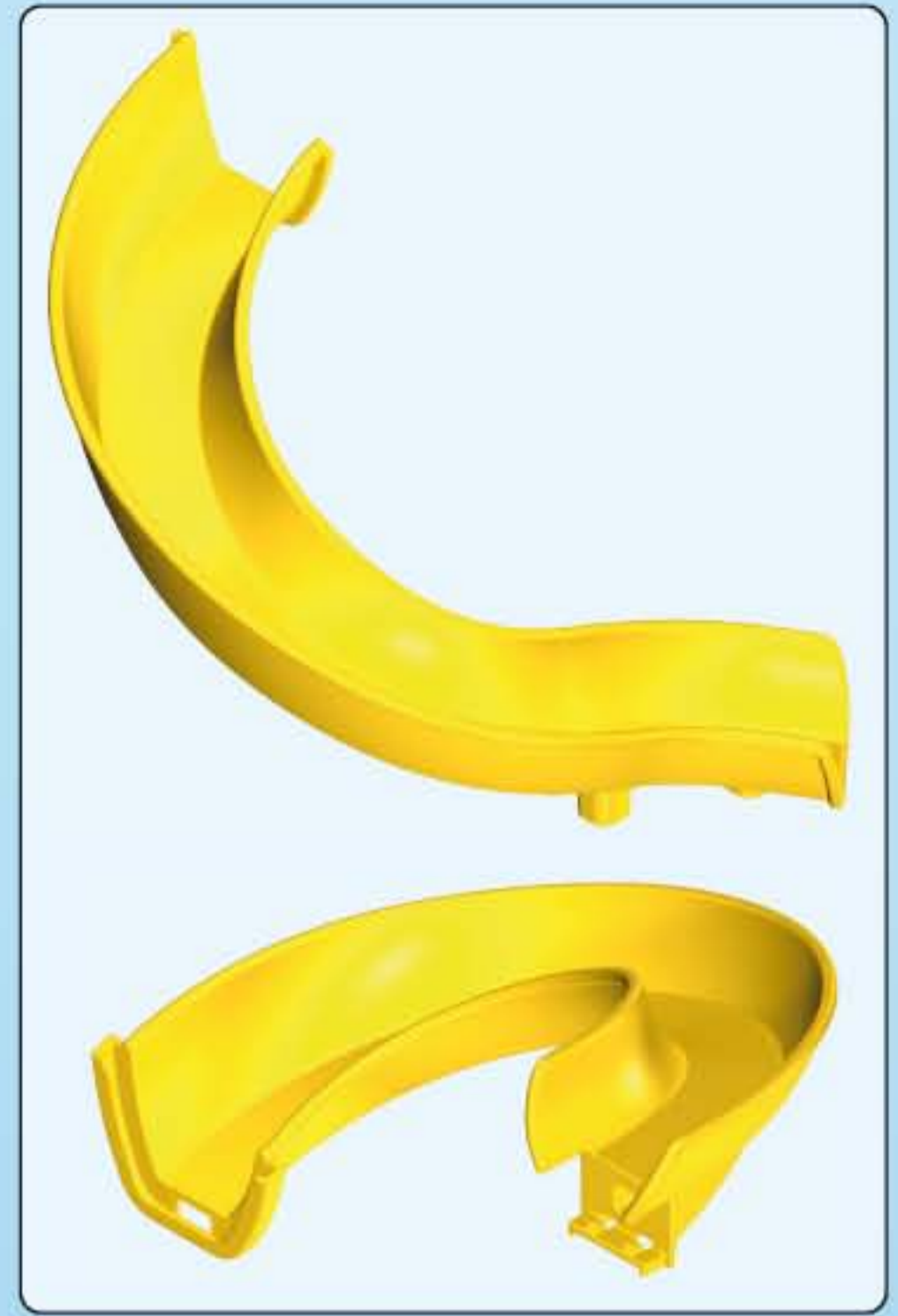

30 51 4522



30 21 9240



30 26 3030



30 23 5403



30 23 5463

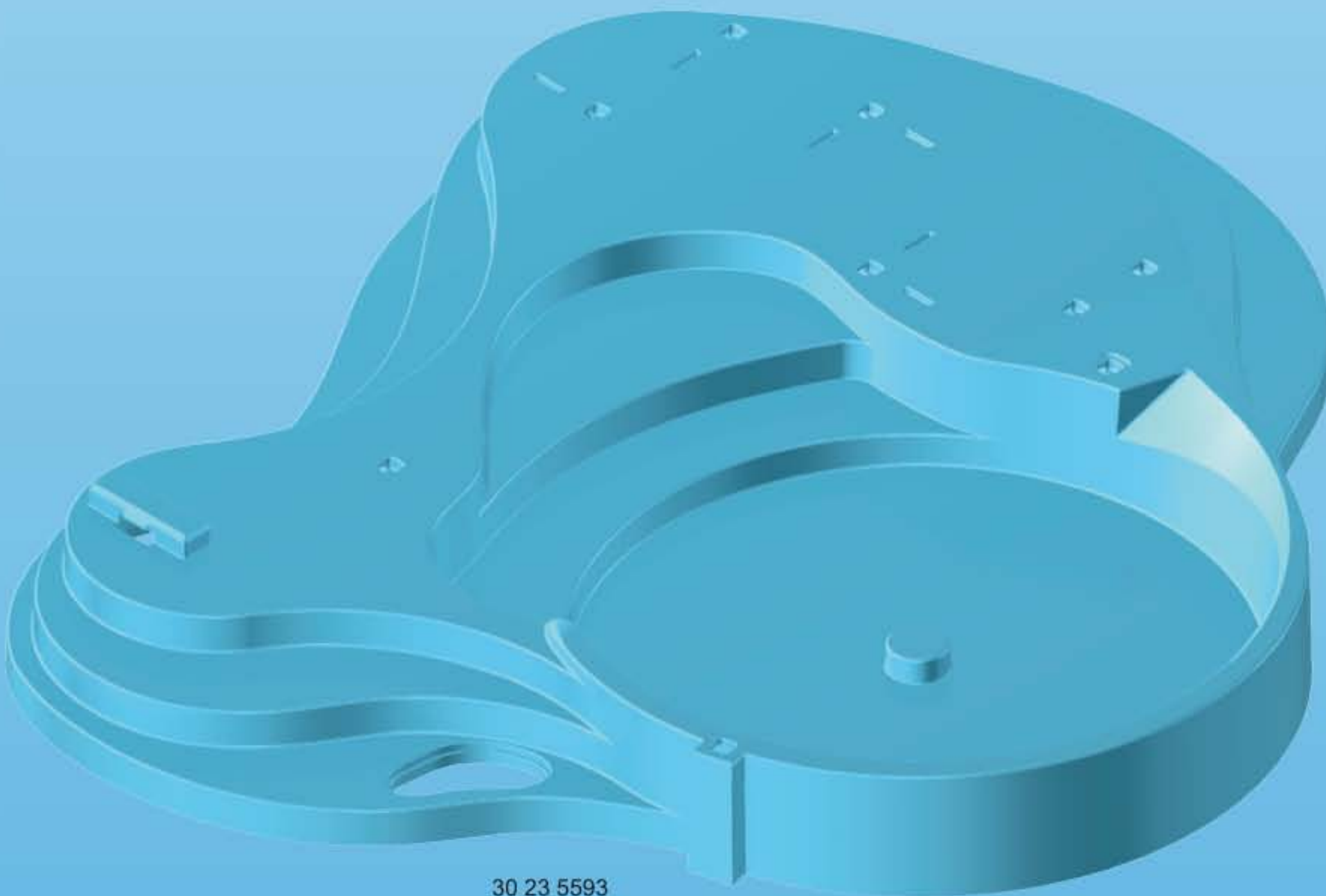

30 23 5593



30 25 9280



30 67 6312



30 23 5453

30 23 5573



30 21 2843



30 23 5583



7x 30 23 5513



2x 30 23 5423



9x 30 23 5533



9x 30 23 5543



30 23 5523



30 23 5493



2x 30 23 5563



9x 30 23 5483



30 82 7603



30 23 5383



30 04 4720



30 23 5603



30 25 9003



30 64 0214



30 88 5870



30 27 6980



3x 30 23 5433



30 23 5333



30 23 5313



4x 30 21 2863



30 23 5393



30 64 0204



30 23 5343



2x 30 23 5303



30 25 7980



30 23 5323



30 02 1220



2x 30 23 5553



2x 30 27 8120



30 23 5443



48x 30 03 6600



4x 30 09 6900



30 20 0200



30 00 5353



30 14 4600



30 11 2290

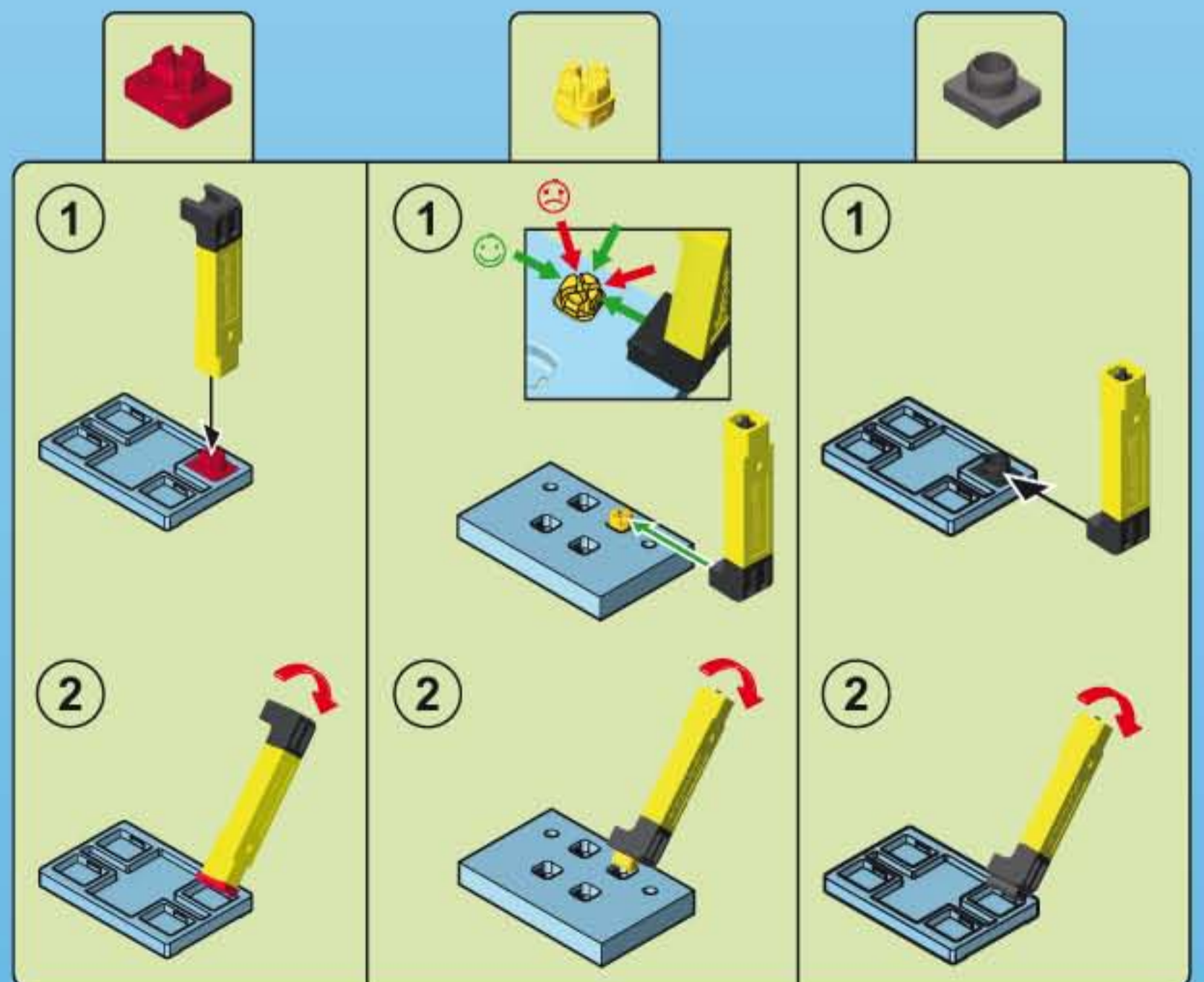

6670 + 6669



1

6669



2



6670



6669

